



CAIMEN GROUP'S HIGH-END BRAND

Shenzhen Caimen Intelligent Technology Co., Ltd. was founded in 2013. It is a modern comprehensive enterprise integrating design, research and development, production, sales and service. The company's R&D team has been deeply engaged in the field of telescopic sliding Gates and has accumulated 15 years of professional and technical experience. With strong technical strength and innovation ability, it has taken a leading position in the industry.

Caimen has an elite team of 130 professionals, including 14 hardware R&D personnel and 20 software R&D personnel. The team has superb technology and outstanding innovation ability. In the past two years, it has achieved fruitful results; successfully obtained 438 patents and 40 software copyrights, 288 trademark layouts, and actively participated in the formulation of 3 national standards, promoting the standardized development of the industry as an industry leader.

Caimen Intelligent Technology has a rich and diverse product line, covering modern entrance and exit security equipment such as smart Villa Gates, Retractable Gates, smart Cantilever Sliding Gates, smart Linear Sliding Gates, smart Telescopic Gates, smart Telescopic Swing Gates, side small Gates,

Internet of Things platforms, smart parking lot charging systems, and smart barriers. The company is committed to providing high-quality intelligent entrance and exit solutions to global customers and continuing to lead the development trend of the industry.

As an industry pioneer focusing on the research and development of telescopic sliding Gates for 15 years, Caimen Intelligent Technology has established a complete production management system, quality management system and service management system in strict accordance with the ISO9001 system to ensure that every link from product design to after-sales service meets high standards. The company takes customer needs as the core and provides a full range of overall channel solutions to help customers achieve safe, intelligent and efficient entrance and exit management.

In the future, Caimen Intelligent Technology will continue to uphold the concept of innovation-driven and quality-oriented, continuously promote technological progress and product upgrades, create greater value for global customers, and continue to lead the development direction of the intelligent entrance and exit industry.

CAIMEN Group Marketing Center





BEIJING TIANANMEN
SQUARE ELECTRIC
GATE SUPPLIER

ENGINEERING **Appreciation**



NATIONAL STADIUM – BIRD'S NEST

SQUARE ENTRANCE AND EXIT
ELECTRIC GATE SUPPLIER



NATIONAL AQUATICS CENTER – WATER CUBE

SQUARE ENTRANCE AND EXIT
ELECTRIC DOOR SUPPLIER

TURNOVER GATE

Turn Over Gate Grand turn
Show your unique personality, you deserve it!

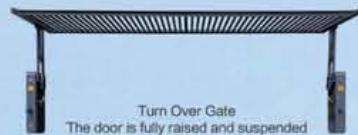

Turn Over Gate
The door is fully raised and suspended



Turn Over Gate
The door was raised and half hung



Turn Over Gate
Door down closed



樊少皇
财门品牌形象代言人
影视功夫巨星



TYFZ-2401
Turn Over Gate

Gate row height is 1.6m
height of the chassis is 1.3m

NO.	1	2	3
Name	Main frame	Inner frame	Vertical bar
Material	6005-T6	6063-T6	6063-T6
Size(mm)	140*63*3.0	59*27*1.8	47*37*1.3
Surface Treatment	Fluorocarbon powder coating		

Flip door series: The longest can do 8 meters, the highest can do 2 meters



TYFZ-2402
Turn Over Gate

Gate row height is 1.6m
height of the chassis is 1.3m

NO.	1	2
Name	Main frame	Gate plate
Material	6005-T6	6063-T6
Size(mm)	150*40*2.0	3.0 AL plate
Surface Treatment	Fluorocarbon powder coating	

CMXM-38

Side Gate
Gate row height is 1.6m



HJ-01

Swing Gate

Door head height 4.06m
Gate row height 2.30m



HJ-02

Swing Gate

Door head height 3.84m
Gate row height 2.30m

Collapsible Gate Schematic Diagram

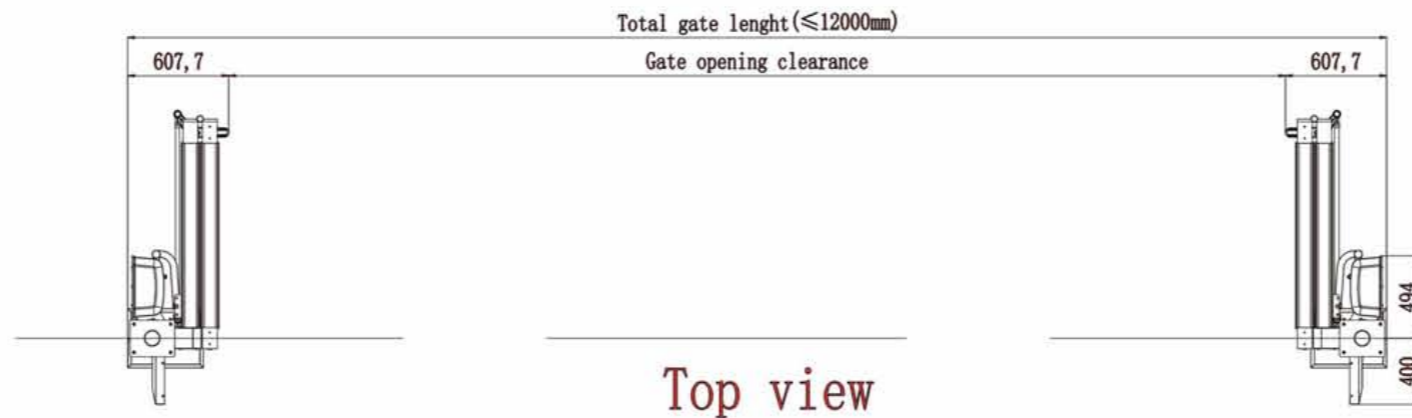
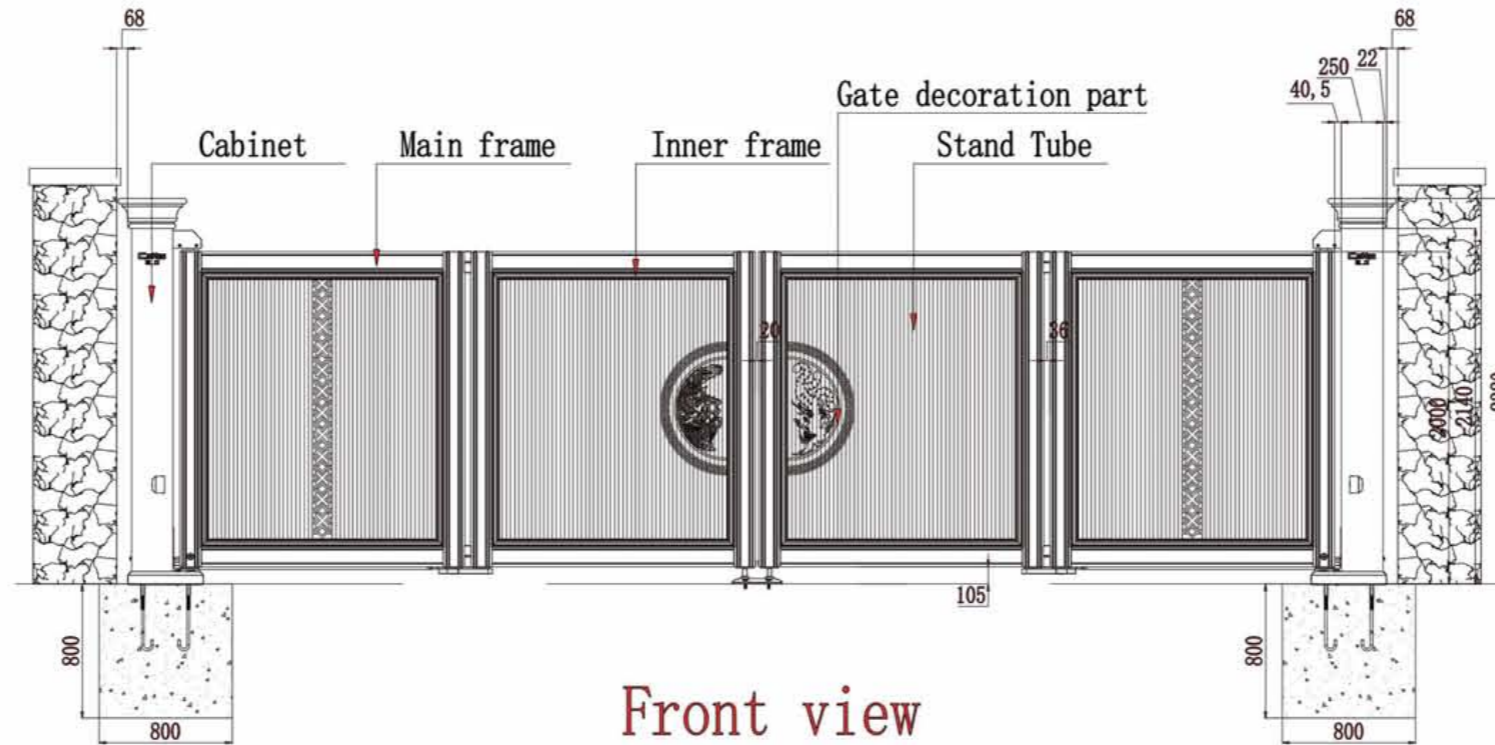

Name	Cabinet	Main frame	Inner frame	Stand Tube	Gate decoration part
Material	6005-T5	6063-T6	6063-T6	6063-T6	6063-T6
Size mm	250*200* Thickness 4.0	128*90* Thickness 3.2	110*50* Thickness 1.5	47*37* Thickness 1.3	AL Casting



CMZD-2001
Collapsible Gate

Gate row height 2.0m
Gatepost height 2.3m

NO.	1	2	3	4	5	6
Name	Cabinet	Main frame	Inner frame	Stand Tube	Decoration part	Drive system
Material	6005-T6	6005-T6	6063-T5	6063-T5	6063-T5	Italy NICE motor
Size(mm)	250*200*4.0	128*90*3.2	110*50*1.5	75*25*1.5	Al die casting	
Surface Treatment	Fluorocarbon powder coating					



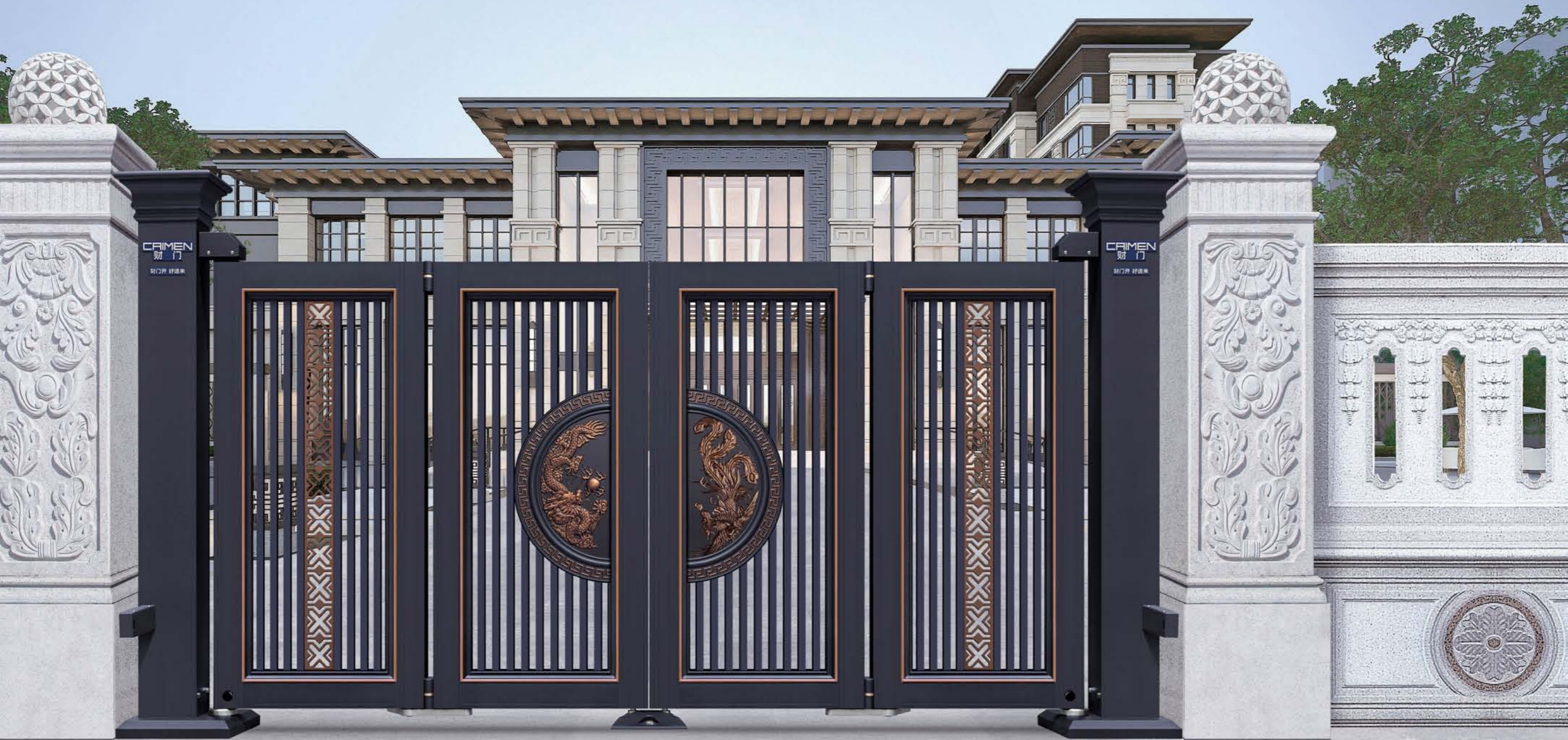

CMZD-2102
Collapsible Gate

Gate row height 2.0m
Gatepost height 2.3m

NO.	1	2	3	4	5	6
Name	Cabinet	Main frame	Inner frame	Stand Tube	Decoration part	Drive system
Material	6005-T6	6005-T6	6063-T5	6063-T5	6063-T5	Italy NICE motor
Size(mm)	250*200*4.0	128*90*3.2	110*50*1.5	25*25*2.0	Al die casting	
Surface Treatment	Fluorocarbon powder coating					



CMZD-1902

Collapsible Gate

Gate row height 2.0m
Gatepost height 2.3m

NO.	1	2	3	4	5	6	7	8
Name	Cabinet	Main frame	Inner frame	Stand Tube	Crossbar	Door row frame materia	Decoration part	Drive system
Material	6005-T6	6005-T6	6063-T5	6063-T5	6063-T5	6063-T5	Aluminum alloy carving	NICE motor imported from Italy
Size(mm)	250*200*4.0	128*90*3.2	110*50*1.5	30*30*2.0	25*25*2.0	40*30*2.0	4.0	
Surface Treatment	Fluorocarbon powder coating							



CMZD-1806

Collapsible Gate

Gate row height 2.0m
Gatepost height 2.3m

NO.	1	2	3	4	5	6	7
Name	Cabinet	Main frame	Inner frame	Stand Tube	Crossbar	Decoration part	Drive system
Material	6005-T6	6005-T6	6063-T5	6063-T5	6063-T5	6063-T5	NICE motor imported from Italy
Size(mm)	250*200*4.0	128*90*3.2	110*50*1.5	25*25*2.0	40*30*2.0	Al die casting	
Surface Treatment	Fluorocarbon powder coating						



CMZD-1815

Collapsible Gate

Gate row height 2.0m
Gatepost height 2.08m

NO.	1	2	3	4	5
Name	Cabinet	Main frame	Crossbar	Decoration part	Drive system
Material	6005-T6	6005-T6	6063-T5	6063-T5	NICE motor imported from Italy
Size(mm)	150*150*3.0	105*70*3.0	76*25*1.5	Al carving	
Surface Treatment	Fluorocarbon powder coating				



CMZD-1811

Collapsible Gate

Gate row height 2.0m
Gatepost height 2.08m

NO.	1	2	3	4	5
Name	Cabinet	Main frame	Crossbar	Decoration part	Drive system
Material	6005-T6	6005-T6	6063-T5	6063-T5	NICE motor imported from Italy
Size(mm)	150*150*3.0	105*70*3.0	76*25*1.5	Al carving	
Surface Treatment	Fluorocarbon powder coating				



CMZD-1812

Collapsible Gate

Gate row height 2.0m
Gatepost height 2.08m

NO.	1	2	3	4	5
Name	Cabinet	Main frame	Crossbar	Decoration part	Drive system
Material	6005-T6	6005-T6	6063-T5	6063-T5	NICE motor imported from Italy
Size(mm)	150*150*3.0	105*70*3.0	76*25*1.5	Al carving	
Surface Treatment	Fluorocarbon powder coating				



XFZD-X9
Collapsible Gate

Gate row height 2.0m
Gatepost height 2.16m

NO.	1	2	3	4	5
Name	Cabinet	Main frame	Inner frame	Gate louver material	Drive system
Material	6005-T6	6005-T6	6063-T5	6063-T5	Italy NICE motor
Size(mm)	250*200*4.0	128*90*3.2	110*50*1.5	60*22*1.2	
Surface Treatment	Fluorocarbon powder coating				

Collapsible Gate Series



XFZD-X8 Collapsible Gate

Gate row height 2.0m
Gatepost height 2.16m

NO.	1	2	3	4	5
Name	Cabinet	Main frame	Inner frame	Gate plate	Drive system
Material	6005-T6	6005-T6	6063-T5	6063-T5	Italy NICE motor
Size(mm)	250*200*4.0	128*90*3.2	110*50*1.5	1.5mm aluminum plate	
Surface Treatment	Fluorocarbon powder coating				



XFZD-X10 Collapsible Gate

Gate row height 2.0m
Gatepost height 2.16m

NO.	1	2	3	4	5	6
Name	Cabinet	Main frame	Inner frame	vertical bar	Gate row plate	Drive system
Material	6005-T6	6005-T6	6063-T5	6063-T5	6063-T5	Italy NICE motor
Size(mm)	250*200*4.0	128*90*3.2	110*50*1.5	47*37*1.3	1.5mm aluminum plate	
Surface Treatment	Fluorocarbon powder coating					



XFZD-X2
Collapsible Gate

Gate row height 2.0m
Gatepost height 2.16m

NO.	1	2	3	4	5
Name	Cabinet	Main frame	Inner frame	Vertical bar	Drive system
Material	6005-T6	6005-T6	6063-T5	6063-T5	Italy NICE motor
Size(mm)	250*200*4.0	128*90*3.2	110*50*1.5	47*37*1.3	
Surface Treatment	Fluorocarbon powder coating				

Collapsible Gate Series



XFZD-X2A

Swing Gate | Gate row height 2.0m
Gatepost height 2.16m



NATURE

Aesthetic



TYPK-2103
Villa Swing Gate
 Gate row height 2.0m
 Gatepost height 2.16m

NO.	1	2	3	4	5
Name	Motor box	Gate main frame	Auxiliary gate frame	Vertical bar	Drive system
Material	6005-T6	6005-T6	6063-T5	6063-T5	Italy NICE motor
Size(mm)	250*200*4.0	128*90*3.2	110*50*1.5	75*25*1.5	
Surface Treatment	Fluorocarbon powder coating				



TYPK-2101
Villa Swing Gate

Support customization

NO.	1	2	3
Name	Gate frame	Vertical bar	Decoration part
Material	6005-T6	6063-T5	6063-T5
Size(mm)	80*80*3.2	40*40*2.0	6.0 thickness
Surface Treatment	Fluorocarbon powder coating		



CAIMEN
财门

TYXF-2401
Villa Sliding Gate
Gate row height 1.6m

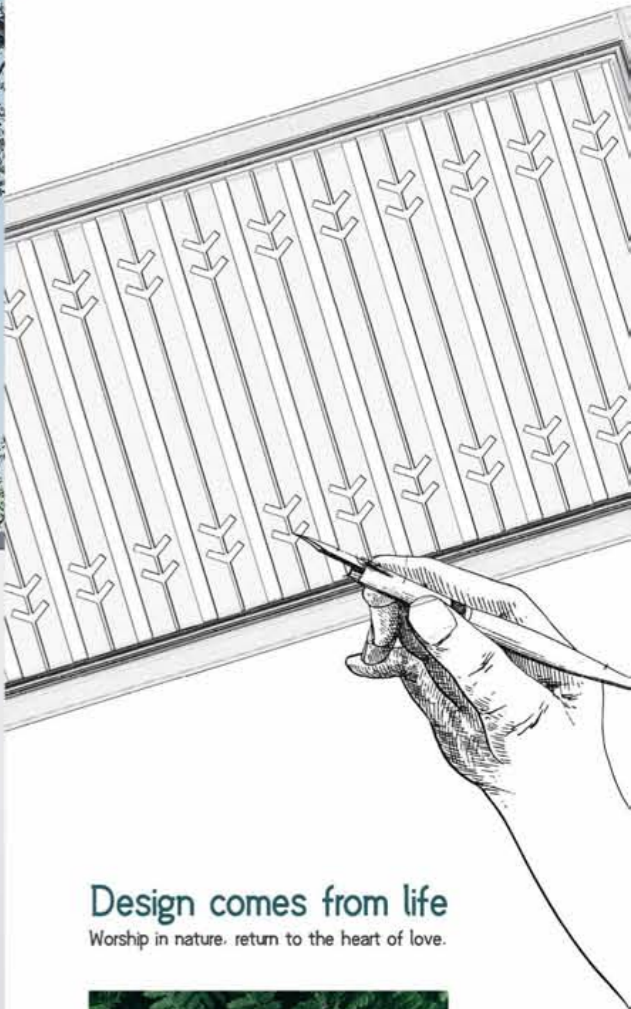

Design comes from life

Worship in nature, return to the heart of love.



TYXF-1805
Villa Sliding Gate

Gate row height 1.6m

NO.	1	2	3	4	5
Name	Gate frame	Auxiliary gate frame	Vertical bar	Decoration part	Drive system
Material	6005-T6	6005-T5	6063-T5	6063-T5	
Size(mm)	140*63*3.0	59*27*1.8	76*25*1.5	8.0mm Al plate carving	Italy NICE motor
Surface Treatment	Fluorocarbon powder coating				



TYXF-1801

Villa Sliding Gate

Gate row height 1.6m

NO.	1	2	3	4
Name	Motor box	Vertical pillar	Top/Bottom beam	Vertical bar
Material	6005-T6	6005-T6	6063-T5	6063-T5
Size(mm)	150*150*3.0	140*89*2.0	140*63*30	50*40*1.3
Surface Treatment	Fluorocarbon powder coating			



TYZW-2101
Sectional Sliding Gate

Gate row height 1.68m

NO.	1	2	3	4
Name	Main gate frame	Auxiliary gate frame	Crossbar	Drive system
Material	6005-T6	6063-T5	6063-T5	Italy NICE motor
Size(mm)	95*63*3.0	59*27*1.8	60*25*1.5	
Surface Treatment	Fluorocarbon powder coating			

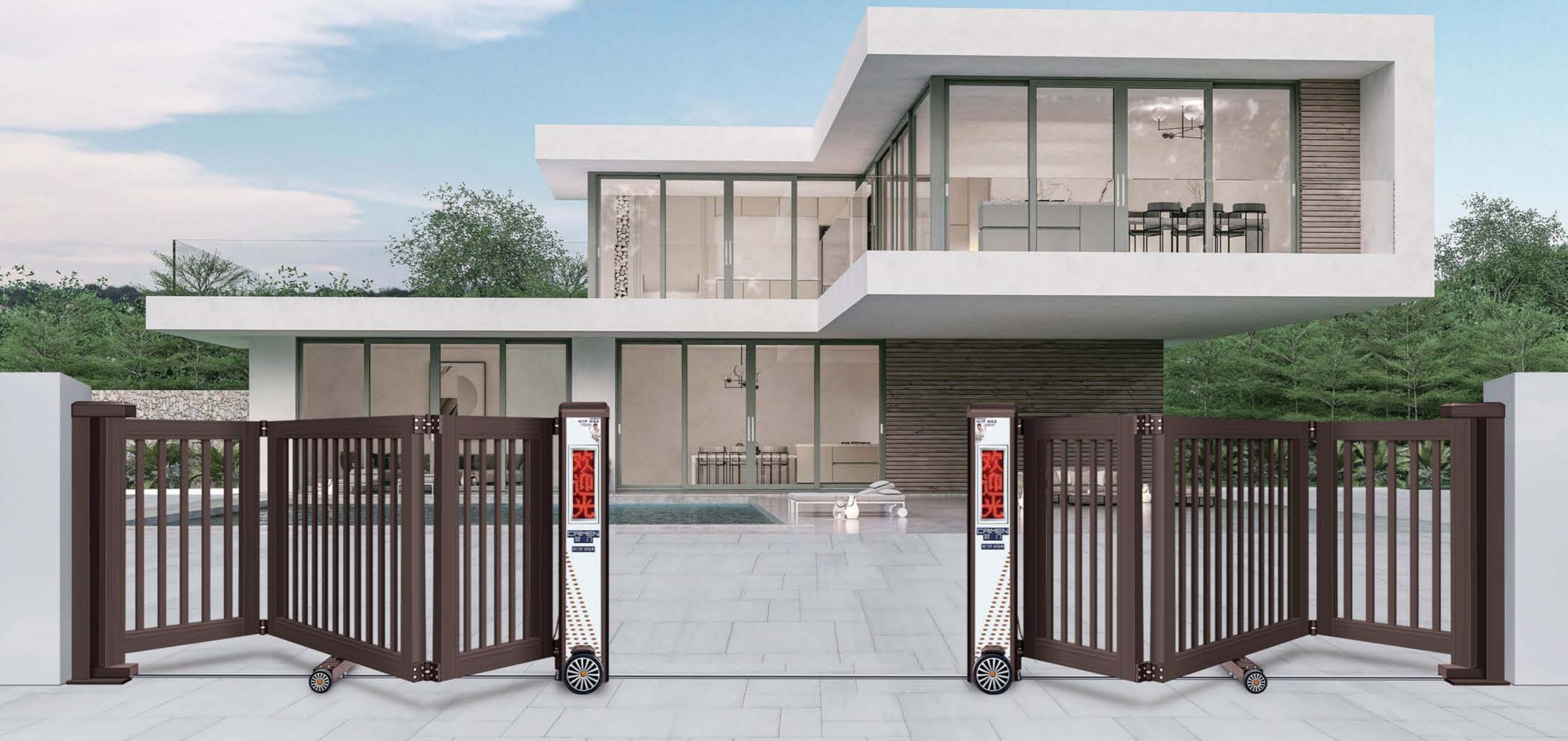

ZS-1905
Collapsible Gate

chassis height is 1.60m
Gate row height 1.52m

NO.	1	2	3	4	5
Name	Cabinet	Vertical pillar	Top/bottom beam	Auxiliary gate frame	Vertical bar
Material	6005-T6	6005-T5	6063-T5	6063-T5	6063-T5
Size(mm)	280*80*3.5	95*68*2.0	95*63*3.0	59*27*1.5	47*37*1.3
Surface Treatment	Fluorocarbon powder coating				



ZS-2401
Collapsible Gate

chassis height is 1.6m
Gate row height 1.52m

NO.	1	2	3	4	5	6	7
Name	Cabinet	Vertical pillar	Top/bottom beam	Auxiliary gate frame	Vertical bar	Crossbar	Decoration part
Material	6005-T6	6005-T5	6063-T5	6063-T5	6063-T5	6063-T5	6063-T5
Size(mm)	280*80*3.5	95*68*2.0	95*63*3.0	59*27*1.5	25*25*2.0	40*30*2.0	47*37*1.3
Surface Treatment	Fluorocarbon powder coating						

Cantilever Sliding Gate Schematic Diagram

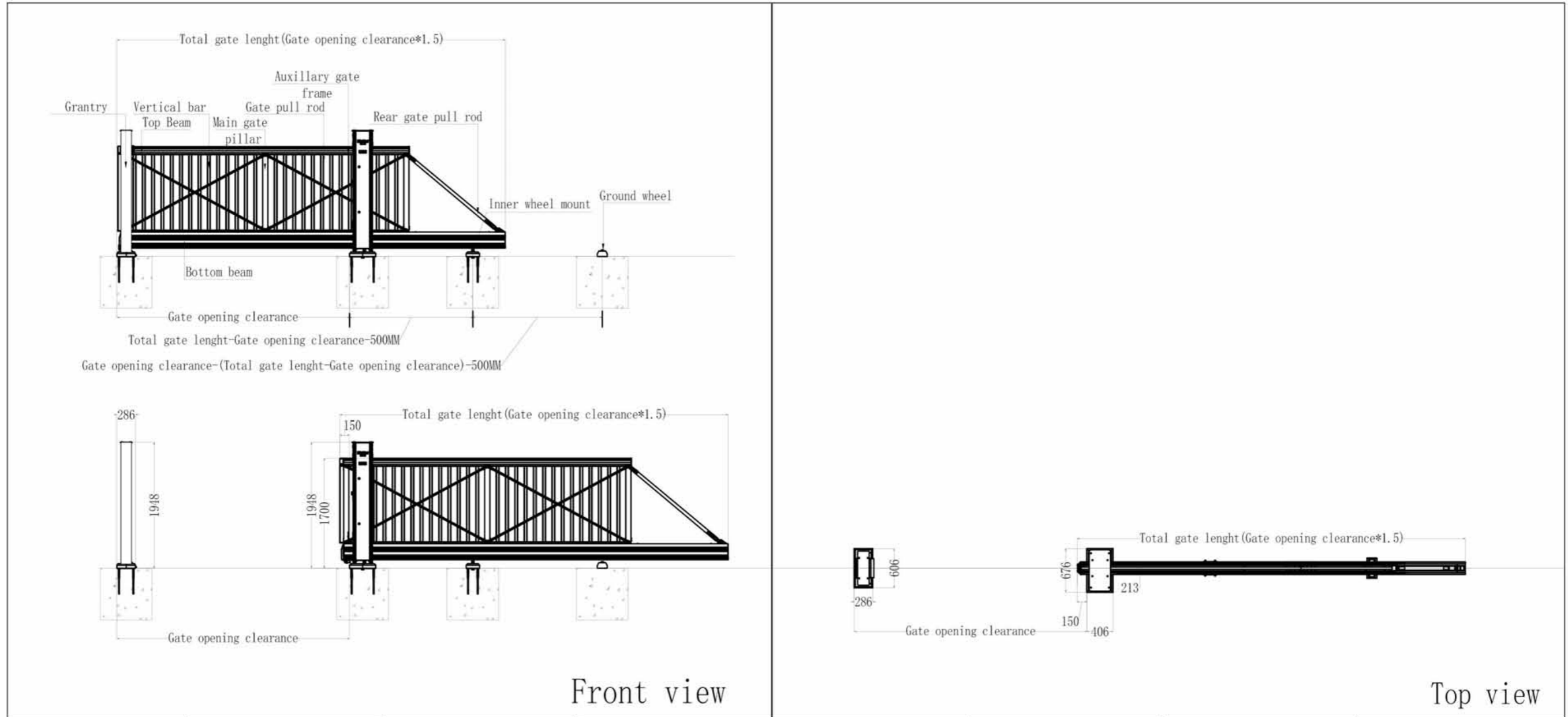

Front view

Top view

Name	Top Beam	Bottom Beam	Gate pull rod	Auxillary gate frame	Main gate pillar	Vertical bar	Gantry
Material	6005-T6	6005-T6	6063-T6	6063-T6	6063-T6	6063-T6	6063-T6
Size mm	113*93* Thickness 2-6	302*213* Thickness 7.0	21六角形	80*40* Thickness 2.0	80*80* Thickness 3.0	47*37*Thickness 1.3	150*100* Thickness 3.0

Smart Entrance And Exit Security Equipment Comprehensive Solutions

- ☑ Smart Electric Gate
- ☑ License Plate Recognition System
- ☑ Vertical Pivot Gate
- ☑ Screen door + Face Recognition

Tip: Customized entrance and exit security solutions can customize corresponding entrance and exit intelligent equipment according to the actual application needs of the company's entrance and exit security sites to meet the appropriate needs of customers.



Cantilever sliding gate

Solve the problem of insufficient installation space of the suspension door



CDXF-2201 Cantilever sliding gate

Gate row height 1.7m

NO.	1	2	3	4	5	6	7	8
Name	Bottom beam	Top beam	Gate pull rod	Rear pull rod	Auxiliary gate frame	Main gate pillar	Vertical bar	Gantry
Material	6005-T6	6063-T5	6063-T6	Q195	6063-T5	6063-T5	6063-T5	6063-T5
Size(mm)	302*213*7.0	113*93*2-6	21 Hexagon	60*40*2.0	80*40*2.0	80*80*3.0	47*37*1.3	150*100*3.0
Surface Treatment	Fluorocarbon powder coating							

Telescopic Cantilever Sliding Gate

Double door row linkage opening and closing, reducing the operating space of door row switch. To solve the problem of the installation of the suspension door in the limited space.



FDXF-2001

Telescopic Cantilever Sliding Gate

Gate row height 1.7m

NO.	1	2	3	4	5	6	7	8
Name	Bottom beam	Top beam	Gate pull rod	Rear pull rod	Auxiliary gate frame	Main gate pillar	Vertical bar	Gantry
Material	6005-T6	6063-T5	6063-T6	Q195	6063-T5	6063-T5	6063-T5	6063-T5
Size(mm)	245*192.5*5-15	113*93*2-6	21 Hexagon	60*40*2.0	80*40*2.0	80*80*3.0	47*37*1.3	150*100*3.0
Surface Treatment	Fluorocarbon powder coating							

CMXM-05

Side Gate

Gate row height 1.6m

NO.	1	2	3	4	5	6
Name	Gate pillar	Top/Bottom beam	Gate vertical frame	Vertical bar	Auxiliary Gate Pillar	Drive system
Material	6005-T6	6063-T5	6063-T5	6063-T5	6005-T6	24V Brushless motor . Can be connected to Face recognition access control system
Size(mm)	100*150*3.0	95*63*2.0	140*89*2.0	47*37*1.3	110*110 *1.5	
Surface Treatment	Fluorocarbon powder coating					



CMXF-1931

Cantilever sliding gate

Gate row height 1.7m

NO.	1	2	3	4	5	6	7	8	9
Name	Bottom beam	Top beam	Gate pull rod	Rear pull rod	Auxiliary gate frame	Main gate pillar	Vertical bar	Decoration part	Gantry
Material	6005-T6	6063-T5	6063-T6	Q195	6063-T5	6063-T5	6063-T5	6063-T5	6063-T5
Size(mm)	302*213*7.0	113*93*2.6	21 Hexagon	60*40*2.0	80*40*2.0	80*80*3.0	75*25*1.5	AL die casting	150*100*3.0
Surface Treatment	Fluorocarbon powder coating								

CMXM-08

Side Gate

Gate row height 1.6m

NO.	1	2	3	4	5	6	7
Name	Gate pillar	Top/Bottom beam	Gate vertical	Vertical bar	Decoration part	Auxiliary Gate Pillar	Drive system
Material	6005-T6	6063-T5	6063-T5	6063-T5	Stainless steel	6063-T6	24V Brushless motor Can be connected to Face recognition access control system
Size(mm)	100*150*3.0	95*63*2.0	140*89*2.0	75*25*1.5	Al plate	110*110*1.5	
Surface Treatment	Fluorocarbon powder coating						

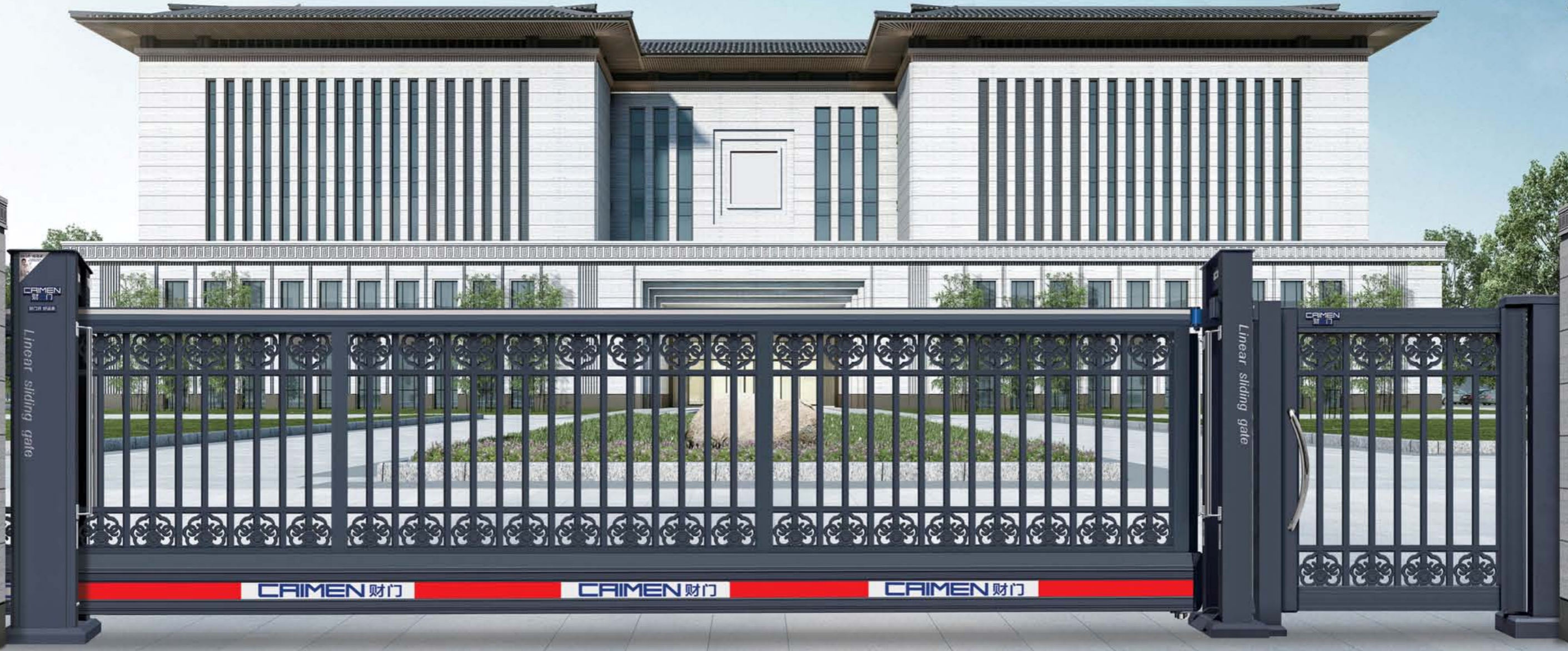

CMXF-2401

Cantilever sliding gate

Gate row height 1.7m

NO.	1	2	3	4	5	6	7	8	9
Name	Bottom beam	Top beam	Gate pull rod	Rear pull rod	Auxiliary gate frame	Main gate pillar	Vertical bar	Decoration part	Gantry
Material	6005-T6	6063-T5	6063-T6	Q195	6063-T5	6063-T5	6063-T5	6063-T5	6063-T5
Size(mm)	302*213*7.0	113*93*2-6	21 Hexagon	60*40*2.0	80*40*2.0	80*80*3.0	25*25*1.5	AL die casting	150*100*3.0
Surface Treatment	Fluorocarbon powder coating								

CMXM-30

Side Gate

Gate row height 1.6m

NO.	1	2	3	4	5	6	7	8
Name	Crossbar	Gate pillar	Top/Bottom beam	Gate vertical	Vertical bar	Auxiliary gate frame	Decoration part	Drive system
Material	6005-T6	6005-T6	6063-T5	6063-T5	6063-T5	6063-T6	6063-T6	24V Brushless motor Can be connected to Face recognition access control system
Size(mm)	30*40*2.0	100*150*3.0	95*63*2.0	140*89*2.0	25*25*2.0	110*110 *1.5	AL die casting	
Surface Treatment	Fluorocarbon powder coating							



CMXF-760

Cantilever sliding gate

Gate row height 1.7m

NO.	1	2	3	4	5	6	7	8
Name	Bottom beam	Top beam	Gate pull rod	Rear pull rod	Auxiliary gate frame	Main gate pillar	Gate row plate	Gantry
Material	6005-T6	6063-T5	6063-T6	Q195	6063-T5	6063-T5	6063-T5	6063-T5
Size(mm)	302*213*7.0	113*93*2-6	21 Hexagon	60*40*2.0	80*40*2.0	80*80*3.0	4.0mm Al plate carving	150*100*3.0
Surface Treatment	Fluorocarbon powder coating							

CMXM-09

Side Gate

Gate row height 1.6m

NO.	1	2	3	4	5	6
Name	Gate pillar	Top/Bottom beam	Gate vertical	Gate plate	Auxiliary Gate Pillar	Drive system
Material	6005-T6	6063-T5	6063-T5	6063-T5	6063-T6	24V Brushless motor , Can be connected to Face recognition access control system
Size(mm)	100*150*3.0	95*63*2.0	140*89*2.0	3.0 Al plate carving	110*110 *1.5	
Surface Treatment	Fluorocarbon powder coating					

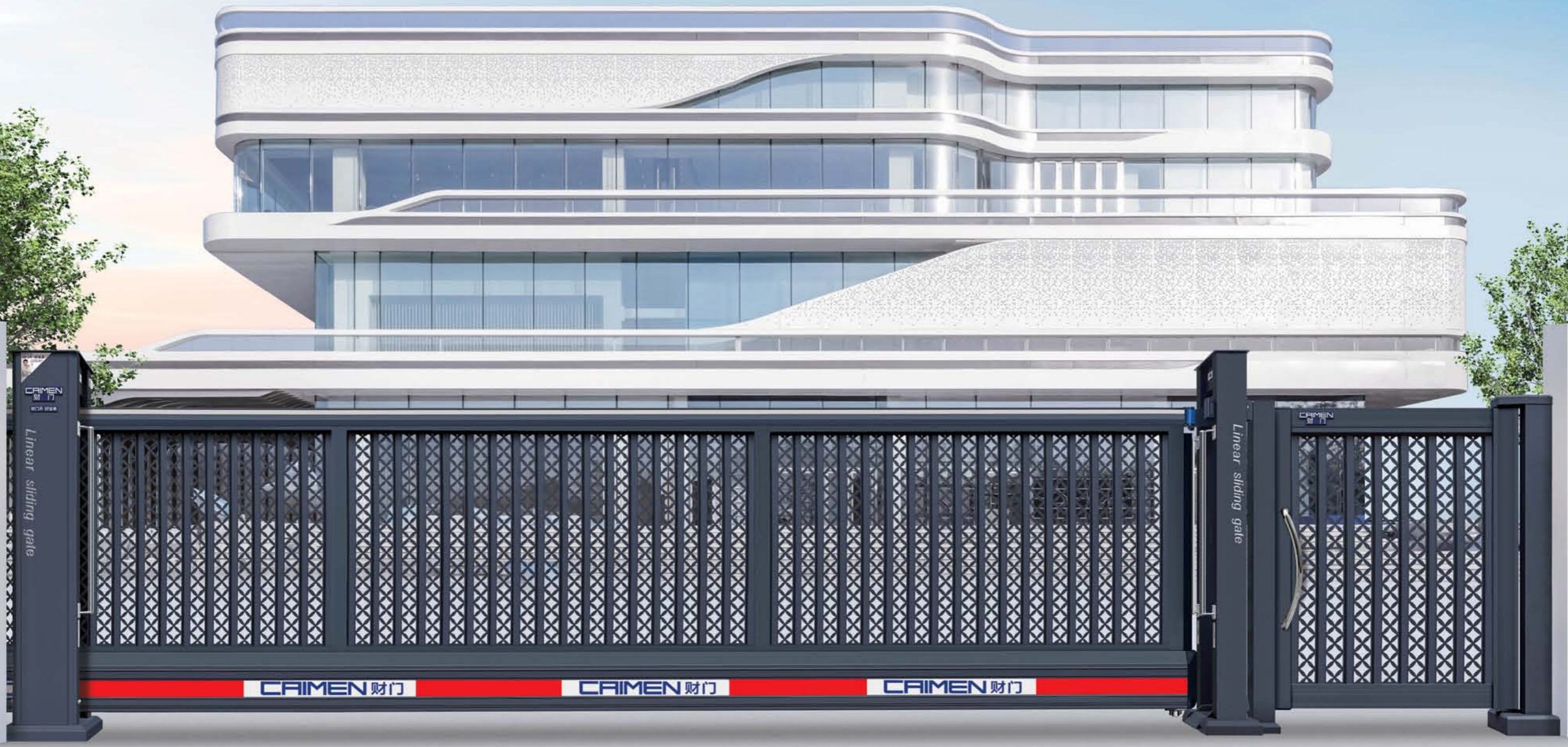

CMXF-740

Cantilever sliding gate

Gate row height 1.7m

NO.	1	2	3	4	5	6	7	8	9
Name	Bottom beam	Top beam	Gate pull rod	Rear pull rod	Auxiliary gate frame	Main gate pillar	Vertical bar	Gate row plate	Gantry
Material	6005-T6	6063-T5	6063-T6	Q195	6063-T5	6063-T5	6063-T5	6063-T5	6063-T5
Size(mm)	302*213*7.0	113*93*2-6	21 Hexagon	60*40*2.0	80*40*2.0	80*80*3.0	47*37*1.3	1.5 mm aluminum plate carving	150*100*3.0
Surface Treatment	Fluorocarbon powder coating								

CMXM-31

Side Gate

Gate row height 1.6m

NO.	1	2	3	4	5	6	7
Name	Gate pillar	Top/Bottom beam	Gate vertical	Vertical bar	Gate plate	Auxiliary Gate Pillar	Drive system
Material	6005-T6	6063-T5	6063-T5	6063-T5	6063-T5	6063-T6	24V Brushless motor , Can be connected to Face recognition access control system
Size(mm)	100*150*3.0	95*63*2.0	140*89*2.0	47*37*1.3	1.5 Al plate carving	110*110 *1.5	
Surface Treatment	Fluorocarbon powder coating						



CMXF-860

Cantilever sliding gate

Gate row height 1.7m

NO.	1	2	3	4	5	6	7	8
Name	Bottom beam	Top beam	Gate pull rod	Rear pull rod	Auxiliary gate frame	Main gate pillar	Gantry	Gate row plate
Material	6005-T6	6063-T5	6063-T6	Q195	6063-T5	6063-T5	6063-T5	Al plate
Size(mm)	302*213*7.0	113*93*2-6	21 Hexagon	60*40*2.0	80*40*2.0	80*80*3.0	150*100*3.0	75*25*1.5
Surface Treatment	Fluorocarbon powder coating							5D Wood Grain Transfer Printing

CMXM-10

Side Gate

Gate row height 1.6m

NO.	1	2	3	4	5	6
Name	Gate pillar	Top/Bottom beam	Gate vertical	Auxiliary Gate Pillar	Gate row plate	Drive system
Material	6005-T6	6063-T5	6063-T5	6063-T6	AL plate	24V Brushless motor . Can be connected to Face recognition access control system
Size(mm)	100*150*3.0	95*63*2.0	140*89*2.0	110*110*1.5	75*25*1.5	
Surface Treatment	Fluorocarbon powder coating				5D Wood Grain Transfer Printing	



CMXF-666

Cantilever sliding gate

Gate row height 1.7m

NO.	1	2	3	4	5	6	7	8
Name	Bottom beam	Top beam	Gate pull rod	Rear pull rod	Auxiliary gate frame	Main gate pillar	Gate louver material	Gantry
Material	6005-T6	6063-T5	6063-T6	Q195	6063-T5	6063-T5	6063-T5	6063-T5
Size(mm)	302*213*7.0	113*93*2-6	21 Hexagon	60*40*2.0	80*40*2.0	80*80*3.0	60*22*1.2	150*100*3.0
Surface Treatment	Fluorocarbon powder coating							

CMXM-07

Side Gate

Gate row height 1.6m

NO.	1	2	3	4	5	6
Name	Gate pillar	Top/Bottom beam	Gate vertical	Gate louver material	Auxiliary Gate Pillar	Drive system
Material	6005-T6	6063-T5	6063-T5	6063-T5	6005-T6	24V Brushless motor , Can be connected to Face recognition access control system
Size(mm)	100*150*3.0	95*63*2.0	140*89*2.0	60*22*1.2	110*110*1.5	
Surface Treatment	Fluorocarbon powder coating					

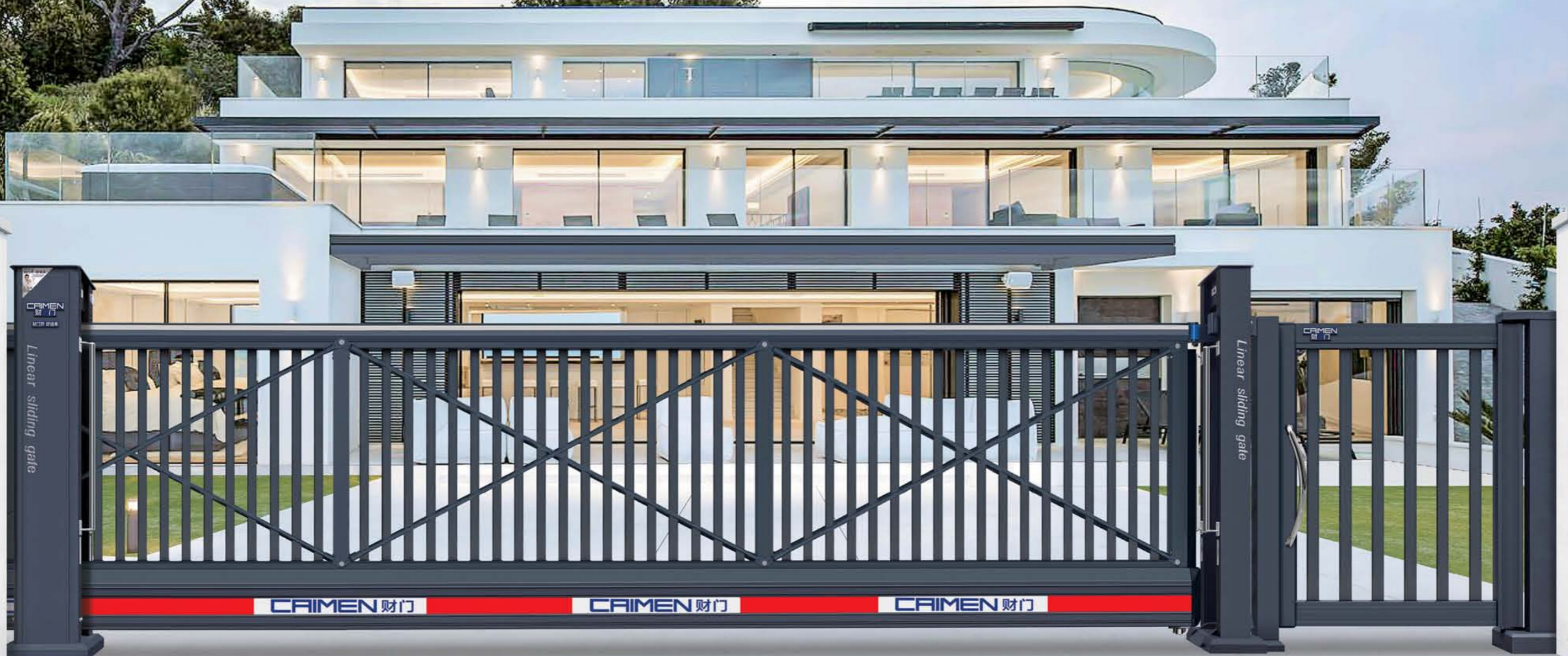

CMXF-735

Cantilever sliding gate

Gate row height 1.7m

NO.	1	2	3	4	5	6	7	8
Name	Bottom beam	Top beam	Gate pull rod	Rear pull rod	Auxiliary gate frame	Main gate pillar	Vertical bar	Gantry
Material	6005-T6	6063-T5	6063-T6	Q195	6063-T5	6063-T5	6063-T5	6063-T5
Size(mm)	302*213*7.0	113*93*2-6	21 Hexagon	60*40*2.0	80*40*2.0	80*80*3.0	47*37*1.3	150*100*3.0
Surface Treatment	Fluorocarbon powder coating							

CMXM-05

Side Gate

Gate row height 1.6m

NO.	1	2	3	4	5	6
Name	Gate pillar	Top/Bottom beam	Gate vertical	Vertical bar	Auxiliary Gate Pillar	Drive system
Material	6005-T6	6063-T5	6063-T5	6063-T5	6063-T6	24V Brushless motor ; Can be connected to Face recognition access control system
Size(mm)	100*150*3.0	95*63*2.0	140*89*2.0	47*37*1.3	110*110 *1.5	
Surface Treatment	Fluorocarbon powder coating					

Cantilever Sliding Gate Schematic Diagram

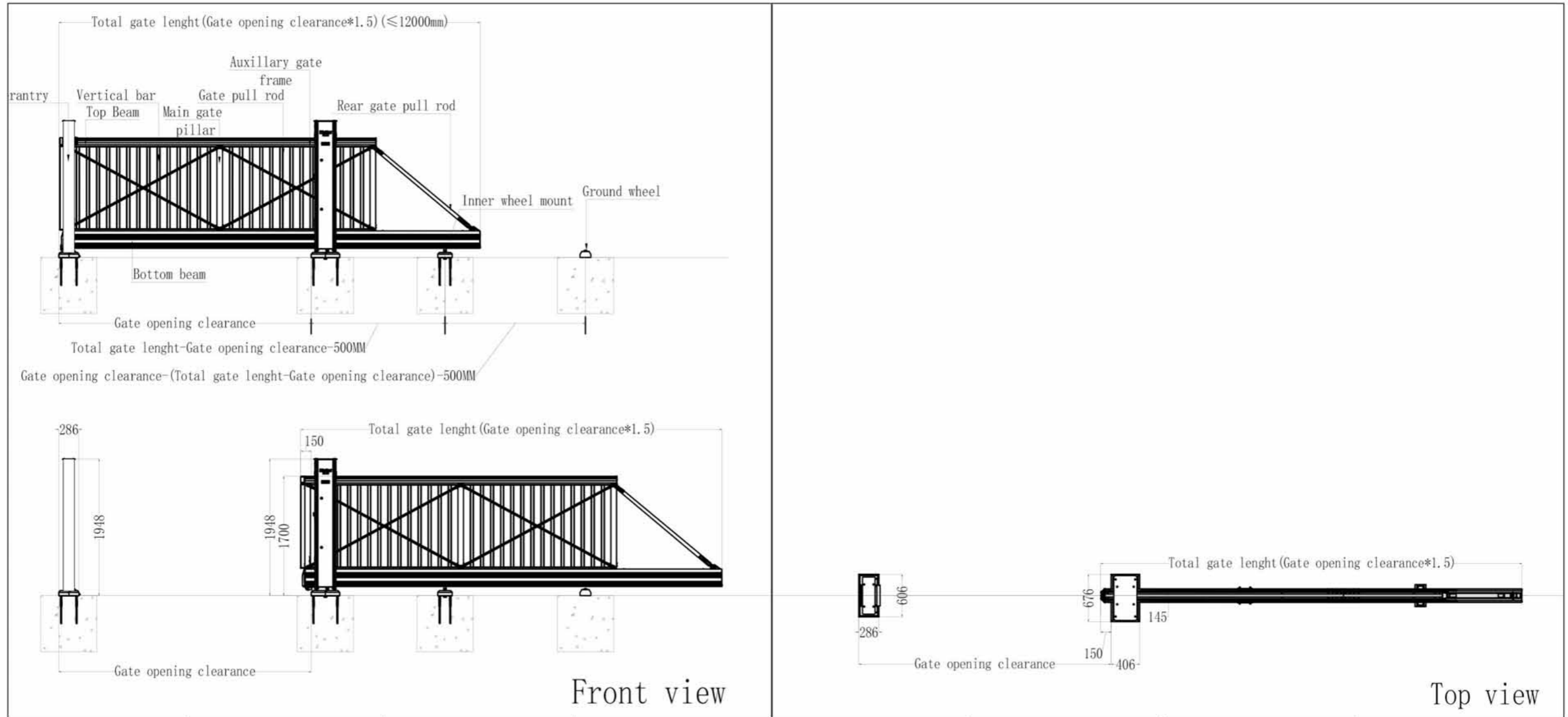

Name	Top Beam	Bottom Beam	Gate pull rod	Auxillary gate frame	Main gate pillar	Vertical bar	Gantry
Material	6005-T6	6005-T6	6063-T6	6063-T6	6063-T6	6063-T6	6063-T6
Size mm	180*145* Thickness 4.0	302*213* Thickness 7.0	21六角形	80*40* Thickness 2.0	80*80* Thickness 3.0	47*37*Thickness 1.3	150*100* Thickness 3.0

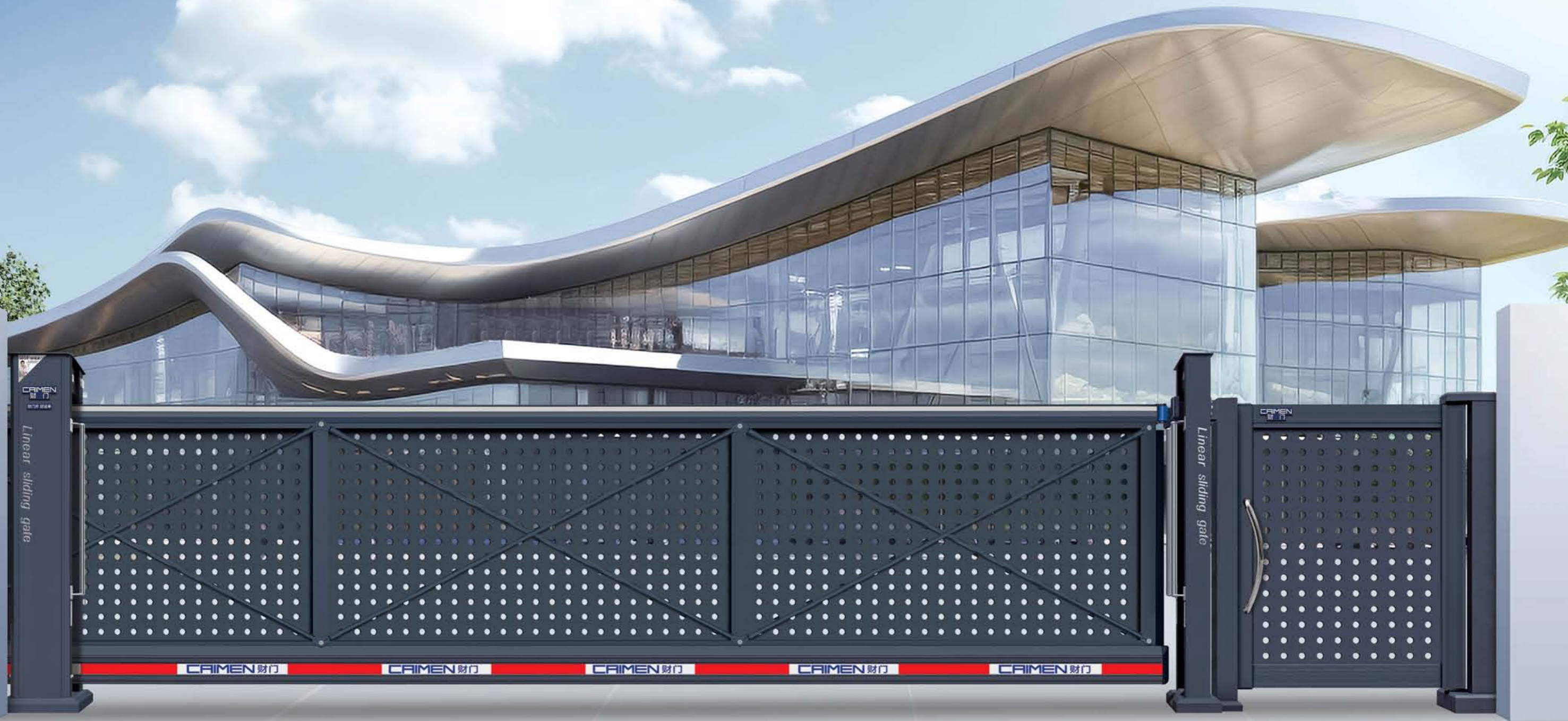

QX-05

Cantilever sliding gate

Gate row height 1.7m

NO.	1	2	3	4	5	6	7	8
Name	Bottom beam	Top beam	Gate pull rod	Rear pull rod	Auxiliary gate frame	Main gate pillar	Gate row plate	Gantry
Material	6005-T6	6063-T5	6063-T6	Q195	6063-T5	6063-T5	6063-T5	6063-T5
Size(mm)	145*185*4.0	113*93*2-6	21 Hexagon	60*40*2.0	80*40*2.0	80*80*3.0	3.0	127*83*2.5
Surface Treatment	Fluorocarbon powder coating							

CMXM-32

Side Gate

Gate row height 1.6m

Linear Sliding Gate

Double door row linkage opening and closing, reducing the operating space of door row switch,

New solutions for smaller holes.

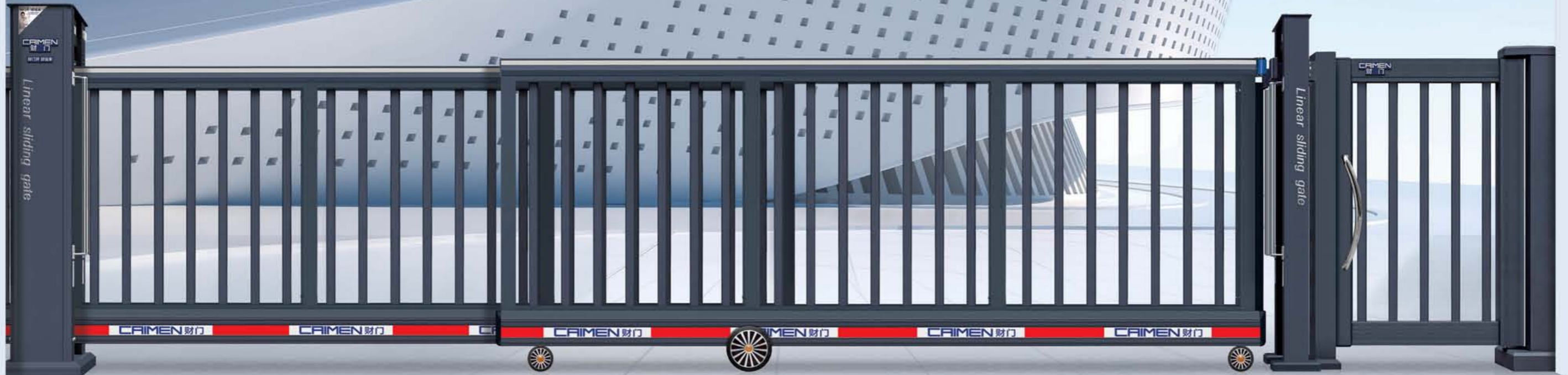

CMFDZX-900

Linear Sliding Gate

Gate row height 1.6m

NO.	1	2	3	4	5	6
Name	Bottom beam	Top beam	Auxiliary gate frame	Gate row main pillar	Vertical bar	Gantry
Material	6005-T6	6005-T5	6063-T5	6063-T5	6063-T5	6063-T5
Size(mm)	185*145*4.0	113*93*2-6	80*40*2.0	80*80*3.0	47*37*1.3	100*100*3.0
Surface Treatment	Fluorocarbon powder coating					

CMXM-05

Side Gate

Gate row height 1.6m

NO.	1	2	3	4	5	6
Name	Gate pillar	Top/Bottom beam	Gate vertical frame	Vertical bar	Auxiliary Gate Pillar	Drive system
Material	6005-T6	6063-T5	6063-T5	6063-T5	6063-T6	24V Brushless motor , Can be connected to Face recognition access control system
Size(mm)	100*150*3.0	95*63*2.0	140*89*2.0	47*37*1.3	110*110 *1.5	
Surface Treatment	Fluorocarbon powder coating					



CMZX-800

Linear Sliding Gate

Gate row height 1.6m

NO.	1	2	3	4	5	6	7
Name	Bottom beam	Top beam	Auxiliary gate frame	Gate row main pillar	Vertical bar	Decoration part	Gantry
Material	6005-T6	6005-T5	6063-T5	6063-T5	6063-T5	6063-T5	6063-T5
Size(mm)	185*145*4.0	113*93*2-6	80*40*2.0	80*80*3.0	75*25*1.3	Al die casting	100*100*3.0
Surface Treatment	Fluorocarbon powder coating						

CMXM-08

Side Gate

Gate row height 1.6m

NO.	1	2	3	4	5	6	7
Name	Gate pillar	Top/Bottom beam	Gate vertical	Vertical bar	Decoration part	Auxiliary Gate Pillar	Drive system
Material	6005-T6	6063-T5	6063-T5	6063-T5	Stainless steel	6063-T6	24V Brushless motor , Can be connected to Face recognition access control system
Size(mm)	100*150*3.0	95*63*2.0	140*89*2.0	75*25*1.5	Al plate	110*110 *1.5	
Surface Treatment	Fluorocarbon powder coating						

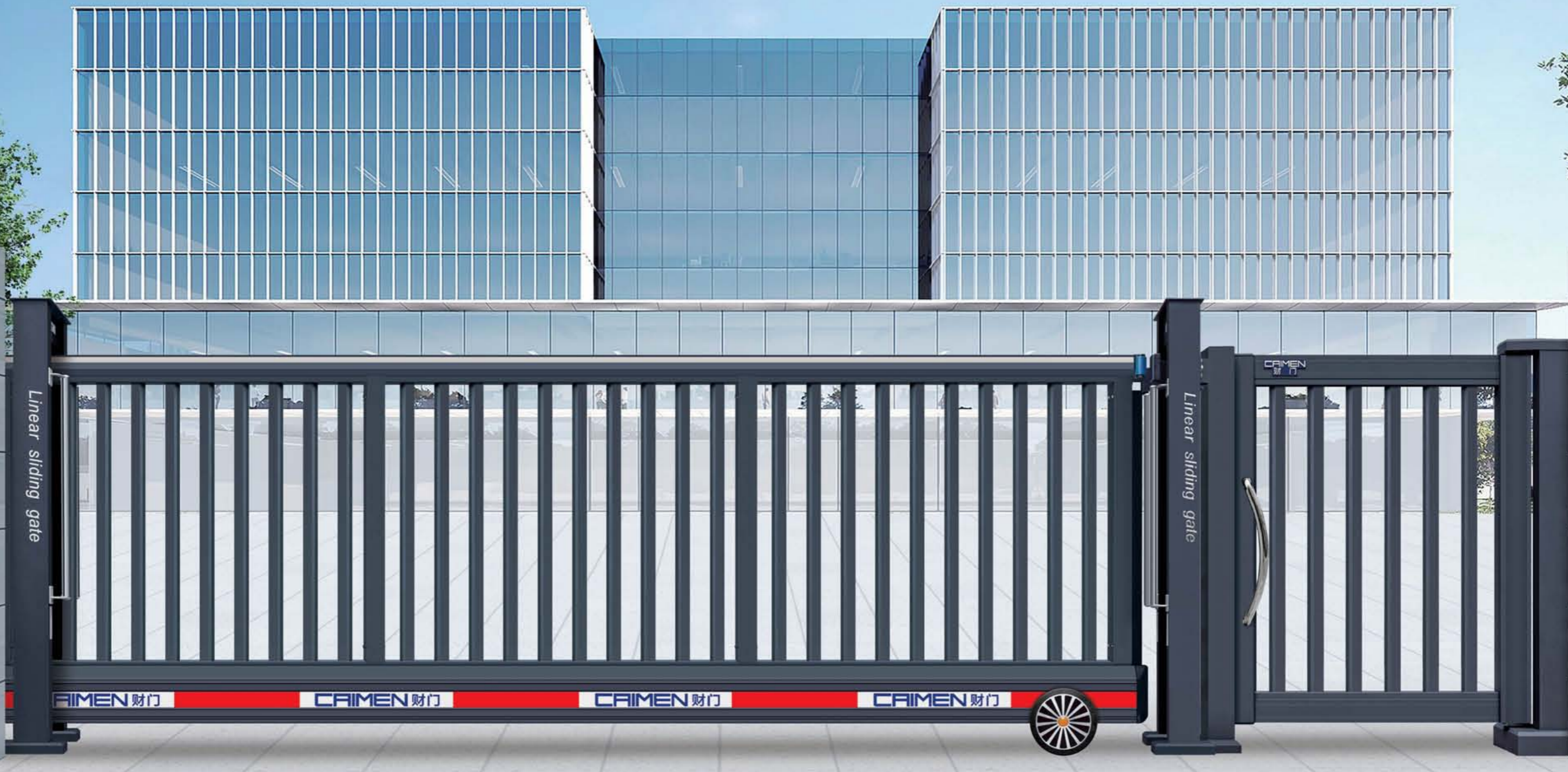

CMZX-100

Linear Sliding Gate

Gate row height 1.6m

NO.	1	2	3	4	5	6
Name	Bottom beam	Top beam	Auxiliary gate frame	Vertical bar	Gate row main pillar	Gantry
Material	6005-T6	6005-T5	6063-T5	6063-T5	6063-T5	6063-T5
Size(mm)	185*145*4.0	113*93*2-6	80*40*2.0	47*37*1.3	80*80*3.0	100*100*3.0
Surface Treatment	Fluorocarbon powder coating					

CMXM-05

Side Gate

Gate row height 1.6m

NO.	1	2	3	4	5	6
Name	Gate pillar	Top/Bottom beam	Gate vertical frame	Vertical bar	Auxiliary Gate Pillar	Drive system
Material	6005-T6	6063-T5	6063-T5	6063-T5	6063-T6	24V Brushless motor , Can be connected to Face recognition access control system
Size(mm)	100*150*3.0	95*63*2.0	140*89*2.0	47*37*1.3	110*110 *1.5	
Surface Treatment	Fluorocarbon powder coating					

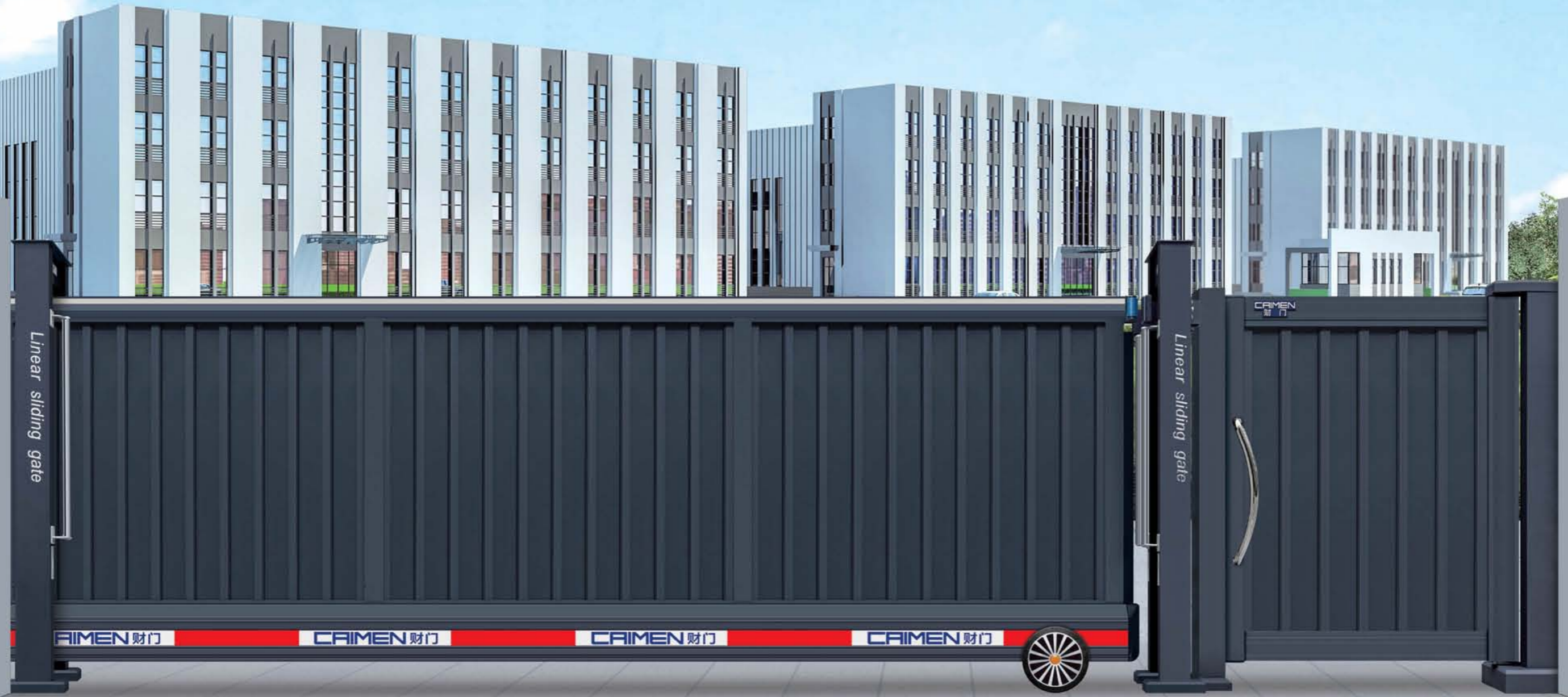

CMZX-700A

Linear Sliding Gate

Gate row height 1.6m

NO.	1	2	3	4	5	6	7
Name	Bottom beam	Top beam	Auxiliary gate frame	Gate row plate	Vertical bar	Gate row main pillar	Gantry
Material	6005-T6	6005-T5	6063-T5	6063-T5	6063-T5	6063-T5	6063-T5
Size(mm)	185*145*4.0	113*93*2-6	80*40*2.0	1.5mm aluminum plate engraving	47*37*1.3	80*80*3.0	100*100*3.0
Surface Treatment	Fluorocarbon powder coating						

CMXM-33

Side Gate

Gate row height 1.6m



Smart Entrance And Exit Security Equipment Comprehensive Solutions

- ✓ Smart Electric Gate
- ✓ License Plate Recognition System
- ✓ Vertical Pivot Gate
- ✓ Side gate + Face Recognition

Tip: Customized entrance and exit security solutions can customize corresponding entrance and exit intelligent equipment according to the actual application needs of the company's entrance and exit security sites to meet the appropriate needs of customers.



CMZC-01 Silver
Telescopic Gate

Gate row height 1.6m

NO.	1	2	3	4	5	6	7
Name	Cabinet	Top beam	Bottom beam	Gate vertical frame	Crossbar	Auxiliary pillar	Vertical bar
Material	6005-T5	6005-T5	6005-T5	6063-T5	6063-T5	6063-T5	6063-T5
Size(mm)	280*80*3.5	122*66*3.0	122*66*3.0	80*90*3.0	60*25*1.0	60*60*1.0	47*37*0.9
Surface Treatment	Fluorocarbon powder coating						

The floral style is common with other series and can be matched at will



CMZC-02 Dark gray

Telescopic Gate

Gate row height 1.6m

The floral style is common with other series and can be matched at will

NO.	1	2	3	4	5	6	7
Name	Cabinet	Top beam	Bottom beam	Gate vertical frame	Crossbar	Auxiliary pillar	Vertical bar
Material	6005-T5	6005-T5	6005-T5	6063-T5	6063-T5	6063-T5	6063-T5
Size(mm)	280*80*3.5	122*66*3.0	122*66*3.0	80*90*3.0	60*25*1.0	60*60*1.0	47*37*0.9
Surface Treatment	Fluorocarbon powder coating						



CMCY-01 Silver

Telescopic Gate

Gate row height 1.6m

NO.	1	2	3	4	5	6	7
Name	Cabinet	Top beam	Bottom beam	Gate vertical frame	Crossbar	Auxiliary pillar	Vertical bar
Material	6005-T5	6005-T5	6005-T5	6063-T5	6063-T5	6063-T5	6063-T5
Size(mm)	280*80*3.5	122*66*3.0	122*66*3.0	80*90*3.0	60*25*1.0	60*60*1.0	47*37*0.9
Surface Treatment	Fluorocarbon powder coating						

The floral style is common with other series and can be matched at will



CMZM-06

Telescopic Gate

Gate row height 1.6m

NO.	1	2	3	4	5	6	7
Name	Cabinet	Top beam	Bottom beam	Gate vertical frame	Crossbar	Auxiliary pillar	Vertical bar
Material	6005-T5	6005-T5	6005-T5	6063-T5	6063-T5	6063-T5	5cm Silver glass + 5cm Silver glass double tempered
Size(mm)	280*80*3.5	122*66*3.0	122*66*3.0	80*90*3.0	60*25*1.0	60*60*1.0	
Surface Treatment	Fluorocarbon powder coating						





CMZM-01
Telescopic Gate
Gate row height 1.6m

NO.	1	2	3	4	5	6	7
Name	Cabinet	Top beam	Bottom beam	Gate row main pillar	Auxiliary gate frame	Auxiliary pillar	Vertical bar
Material	6005-T5	6005-T5	6005-T5	6063-T5	6063-T5	6063-T5	6063-T5
Size(mm)	280*80*3.5	122*66*3.0	122*66*3.0	80*90*3.0	60*25*1.0	60*60*1.0	Φ30*1.0
Surface Treatment	Fluorocarbon powder coating						



CMZM-02
Telescopic Gate
Gate row height 1.6m

NO.	1	2	3	4	5	6	7
Name	Cabinet	Top beam	Bottom beam	Gate row main pillar	Auxiliary gate frame	Auxiliary pillar	Vertical bar
Material	6005-T5	6005-T5	6005-T5	6063-T5	6063-T5	6063-T5	6063-T5
Size(mm)	280*80*3.5	122*66*3.0	122*66*3.0	80*90*3.0	60*25*1.0	60*60*1.0	47*37*0.9
Surface Treatment	Fluorocarbon powder coating						



CMZM-03 Silver
Telescopic Gate
Gate row height 1.6m

NO.	1	2	3	4	5	6	7
Name	Cabinet	Top beam	Bottom beam	Gate vertical frame	Crossbar	Auxiliary pillar	Vertical bar
Material	6005-T5	6005-T5	6005-T5	6063-T5	6063-T5	6063-T5	6063-T5
Size(mm)	280*80*3.5	122*66*3.0	122*66*3.0	80*90*3.0	60*25*1.0	60*60*1.0	47*37*0.9
Surface Treatment	Fluorocarbon powder coating						



CMZK-01 Telescopic Gate

Gate row height 1.6m

NO.	1	2	3	4	5	6
Name	Motor box pillar	Gate row main pillar	Gate row auxiliary pillar	Top/Bottom beam	Crossbar	Vertical bar
Material	6005-T5	6005-T5	6005-T5	6063-T5	6063-T5	6063-T5
Size(mm)	90*75*2.0	70*70*1.5	70*70*1.2	118*56*2.0	50*25*0.8	47*37*0.8
Surface Treatment	Fluorocarbon powder coating					

Gate width 610mm, Standard height 1600mm (ground to highest point), Maximum 6 sections



CMZK-02 Silver Telescopic Gate

Gate row height 1.6m

Gate width 610mm, Standard height 1600mm (ground to highest point), Maximum 6 sections

NO.	1	2	3	4	5	6
Name	Motor box pillar	Gate row main pillar	Gate row auxiliary pillar	Top/Bottom beam	Crossbar	Vertical bar
Material	6005-T5	6005-T5	6005-T5	6063-T5	6063-T5	6063-T5
Size(mm)	90*75*2.0	70*70*1.5	70*70*1.2	118*56*2.0	50*25*0.8	47*37*0.8
Surface Treatment	Fluorocarbon powder coating					



CMZY-01
Telescopic Gate
Gate row height 1.6m

NO.	1	2	3	4	5
Name	Top/Bottom beam	Gate row main pillar	Gate row auxiliary pillar	Crossbar	Vertical bar
Material	6005-T5	6005-T5	6005-T5	6063-T5	6063-T5
Size(mm)	118*56*2.0	70*70*1.5	70*70*1.2	50*25*0.8	47*37*0.8
Surface Treatment	Fluorocarbon powder coating				

NO.	1	2	3	4	5	6
Name	Gate pillar	Top/Bottom beam	Gate vertical	Vertical bar	Auxiliary Gate Pillar	Drive system
Material	6005-T6	6063-T5	6063-T5	6063-T5	6063-T6	24V Brushless motor , Can be connected to Face recognition access control system
Size(mm)	100*150*3.0	95*63*2.0	140*89*2.0	47*37*1.3	110*110 *1.5	
Surface Treatment	Fluorocarbon powder coating					

CMXM-05
Side Gate
Gate row height 1.6m



CMZY-02 Silver
Telescopic Gate
Gate row height 1.6m

NO.	1	2	3	4	5
Name	Top/Bottom beam	Gate row main pillar	Gate row auxiliary pillar	Crossbar	Vertical bar
Material	6005-T5	6005-T5	6005-T5	6063-T5	6063-T5
Size(mm)	118*56*2.0	70*70*1.5	70*70*1.2	50*25*0.8	47*37*0.8
Surface Treatment	Fluorocarbon powder coating				

NO.	1	2	3	4	5	6
Name	Gate pillar	Top/Bottom beam	Gate vertical	Vertical bar	Auxiliary Gate Pillar	Drive system
Material	6005-T6	6063-T5	6063-T5	6063-T5	6063-T6	24V Brushless motor, Can be connected to Face recognition access control system
Size(mm)	100*150*3.0	95*63*2.0	140*89*2.0	47*37*1.3	110*110*1.5	
Surface Treatment	Fluorocarbon powder coating					

CMXM-05
Side Gate
Gate row height 1.6m

Telescopic Swing Gate Schematic Diagram

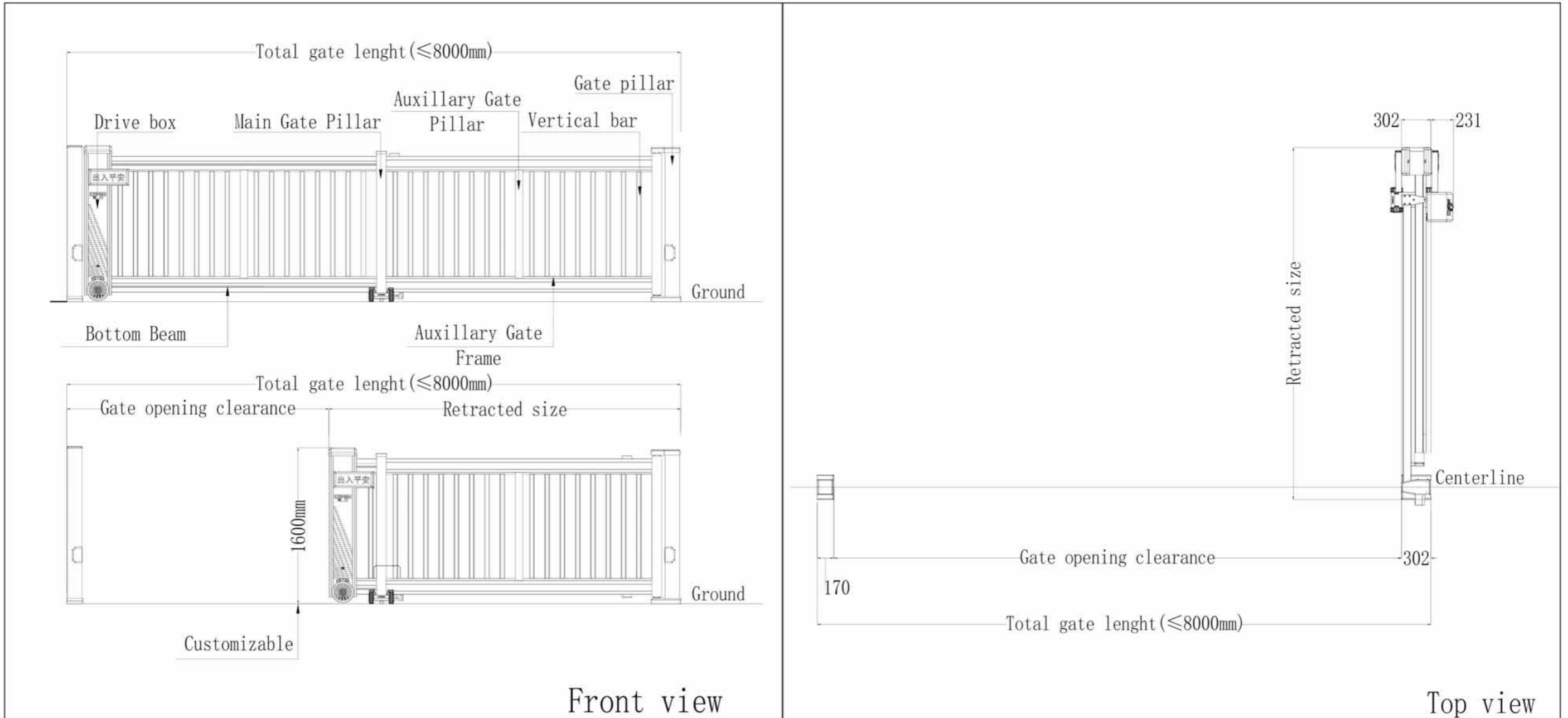

Front view

Top view

Name	Drive box	Top Beam	Bottom Beam	Auxillary Gate Pillar	Main Gate Pillar	Auxillary Gate Frame	Vertical bar	Gate pillar
Material	6063-T6	6063-T6	6063-T6	6063-T6	6063-T6	6063-T6	6063-T6	6063-T6
Size mm	280*80*Thickness 3.0	140*83*Thickness 4.0		76*76*Thickness 1.0	100*100*Thickness 3.0	76*25*Thickness 1.5	47*37*Thickness 1.3	150*150*Thickness 1.3



CMPZ-1801 Silver Telescopic Swing Gate

Gate row height 1.6m

NO.	1	2	3	4	5	6	7
Name	Cabinet	Auxiliary gate pillar	Bottom beam	Top beam	Main gate pillar	Auxiliary gate frame	Gate vertical bar
Material	6005-T6	6005-T5	6063-T5	6063-T5	6063-T5	6063-T5	6063-T5
Size(mm)	280*80*3.5	150*150*3.0	140*83*4.0	140*83*4.0	100*100*3.0	76*25*1.5	47*37*1.3
Surface Treatment	Fluorocarbon powder coating						

※The style is common with telescopic gates and can be selected at will.



CMPZ-1805 Telescopic Swing Gate

Gate row height 1.6m

NO.	1	2	3	4	5	6	7
Name	Cabinet	Auxiliary gate pillar	Bottom beam	Top beam	Main gate pillar	Auxiliary gate frame	Gate vertical bar
Material	6005-T6	6005-T5	6063-T5	6063-T5	6063-T5	6063-T5	6063-T5
Size(mm)	280*80*3.5	150*150*3.0	140*83*4.0	140*83*4.0	100*100*3.0	76*25*1.5	47*37*1.3 57*47*1.3
Surface Treatment	Fluorocarbon powder coating						

※The style is common with telescopic gates and can be selected at will.

Telescopic Gate-CMZK

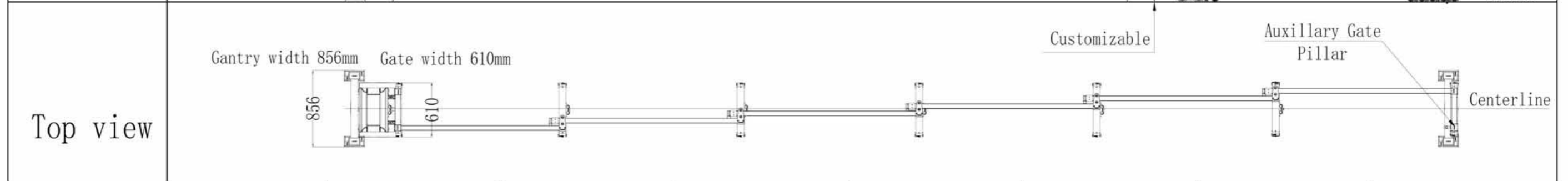
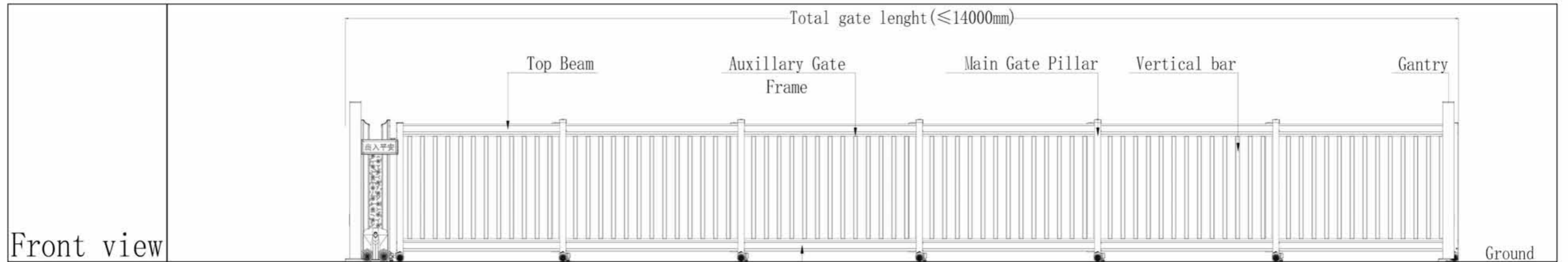

Name	Top Beam	Top Beam	Bottom Beam	Auxillary Gate Pillar	Main Gate Pillar	Auxillary Gate Frame	Vertical bar	Gantry
Material	6063-T6	6063-T6	6063-T6	6063-T6	6063-T6	6063-T6	6063-T6	6063-T6
Size mm	90*75*Thickness 2.0	118*56*Thickness 2.0		70*70*Thickness 1.2	70*70*Thickness 1.5	50*25*Thickness 0.8	47*37*Thickness 0.8	127*83*Thickness 2.5



HAOYUN-26

Telescopic Gate

Gate row height 1.6m

NO.	1	2	3	4	5	6	7	8
Name	Bottom beam	Top beam	Main gate pillar	Auxiliary gate frame	Auxiliary gate pillar	Vertical bar	Gate row plate	Gantry
Material	6005-T5	6005-T5	6063-T5	6063-T5	6063-T5	6063-T5	6063-T5	6063-T5
Size(mm)	140*83*4.0	140*83*4.0	100*100*3.0	76*25*1.5	76*76*1.5	47*37*1.3	1.5mm AL plate carving	127*83*2.5
Surface Treatment	Fluorocarbon powder coating							

NO.	1	2	3	4	5	6	7
Name	Gate pillar	Top/Bottom beam	Gate vertical frame	Vertical bar	Gate plate	Auxiliary Gate Pillar	Drive system
Material	6005-T6	6063-T5	6063-T5	6063-T5	6063-T5	6063-T6	24V Brushless motor . Can be connected to Face recognition access control system
Size(mm)	100*150*3.0	95*63*2.0	140*89*2.0	47*37*1.3	1.5 Al plate	110*110 *1.5	
Surface Treatment	Fluorocarbon powder coating						

CMXM-21

Side Gate

Gate row height 1.6m



HAOYUN-888

Telescopic Gate

Gate row height 1.6m

NO.	1	2	3	4	5	6	7
Name	Bottom beam	Top beam	Main gate pillar	Auxiliary gate frame	Auxiliary gate pillar	Vertical bar	Gantry
Material	6005-T5	6005-T5	6063-T5	6063-T5	6063-T5	6063-T5	6063-T5
Size(mm)	140*83*4.0	140*83*4.0	100*100*3.0	76*25*1.5	76*76*1.5	47*37*1.3	127*83*2.5
Surface Treatment	Fluorocarbon powder coating						

NO.	1	2	3	4	5	6	7	8
Name	Gate pillar	Top/Bottom beam	Gate vertical frame	Vertical bar	Gate plate	Crossbar	Auxiliary Gate Pillar	Drive system
Material	6005-T6	6063-T5	6063-T5	6063-T5	6063-T5	6063-T6	6063-T6	24V Brushless motor, Can be connected to Face recognition access control system
Size(mm)	100*150*3.0	95*63*2.0	140*89*2.0	40*40*2.0 30*40*2.0	1.5 Al plate	2.5*2.5 *2.0	110*110 *1.5	
Surface Treatment	Fluorocarbon powder coating							

CMXM-28

Side Gate

Gate row height 1.6m

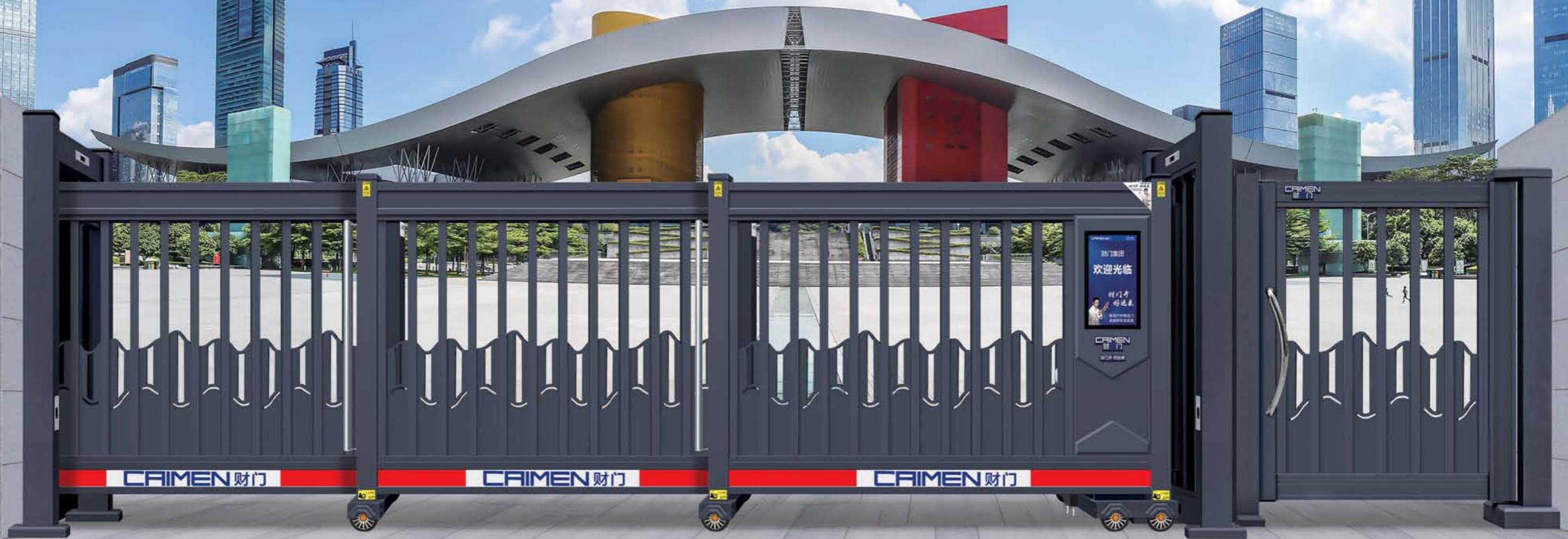

HAOYUN-25

Telescopic Gate

Gate row height 1.6m

NO.	1	2	3	4	5	6	7	8
Name	Bottom beam	Top beam	Main gate pillar	Auxiliary gate frame	Auxiliary gate pillar	Vertical bar	Gate row plate	Gantry
Material	6005-T5	6005-T5	6063-T5	6063-T5	6063-T5	6063-T5	6063-T5	6063-T5
Size(mm)	140*83*4.0	140*83*4.0	100*100*3.0	76*25*1.5	76*76*1.5	47*37*1.3	1.5mm AL plate carving	127*83*2.5
Surface Treatment	Fluorocarbon powder coating							

NO.	1	2	3	4	5	6	7
Name	Gate pillar	Top/Bottom beam	Gate vertical frame	Vertical bar	Gate plate	Auxiliary Gate Pillar	Drive system
Material	6005-T6	6063-T5	6063-T5	6063-T5	6063-T5	6063-T6	24V Brushless motor, Can be connected to Face recognition access control system
Size(mm)	100*150*3.0	95*63*2.0	140*89*2.0	47*37*1.3	1.5 Al plate	110*110 *1.5	
Surface Treatment	Fluorocarbon powder coating						

CMXM-11

Side Gate

Gate row height 1.6m



HAOYUN-20

Telescopic Gate

Gate row height 1.6m

NO.	1	2	3	4	5	6	7	8
Name	Bottom beam	Top beam	Main gate pillar	Auxiliary gate frame	Auxiliary gate pillar	Vertical bar	Decoration part	Gantry
Material	6005-T5	6005-T5	6063-T5	6063-T5	6063-T5	6063-T5	6063-T5	6063-T5
Size(mm)	140*83*4.0	140*83*4.0	100*100*3.0	76*25*1.5	76*76*1.5	47*37*1.3	AL casting	127*83*2.5
Surface Treatment				Fluorocarbon powder coating				

NO.	1	2	3	4	5	6	7
Name	Gate pillar	Top/Bottom beam	Gate vertical frame	Vertical bar	Gate plate	Auxiliary Gate Pillar	Drive system
Material	6005-T6	6063-T5	6063-T5	6063-T5	6063-T5	6063-T6	24V Brushless motor Can be connected to Face recognition access control system
Size(mm)	100*150*3.0	95*63*2.0	140*89*2.0	47*37*1.3	1.5 Al plate	110*110*1.5	
Surface Treatment			Fluorocarbon powder coating				

CMXM-36

Side Gate

Gate row height 1.6m



HAOYUN-21

Telescopic Gate

Gate row height 1.6m

NO.	1	2	3	4	5	6	7	8
Name	Bottom beam	Top beam	Main gate pillar	Auxiliary gate frame	Auxiliary gate pillar	Vertical bar	Decoration part	Gantry
Material	6005-T5	6005-T5	6063-T5	6063-T5	6063-T5	6063-T5	6063-T5	6063-T5
Size(mm)	140*83*4.0	140*83*4.0	100*100*3.0	76*25*1.5	76*76*1.5	75*25*1.5	AL die casting	127*83*2.5
Surface Treatment	Fluorocarbon powder coating							

NO.	1	2	3	4	5	6	7
Name	Gate pillar	Top/Bottom beam	Gate vertical frame	Vertical bar	Decoration part	Auxiliary Gate Pillar	Drive system
Material	6005-T6	6063-T5	6063-T5	6063-T5	Stainless steel	6063-T6	24V Brushless motor , Can be connected to Face recognition access control system
Size(mm)	100*150*3.0	95*63*2.0	140*89*2.0	75*25*1.5	Al plate	110*110 *1.5	
Surface Treatment	Fluorocarbon powder coating						

CMXM-08

Side Gate

Gate row height 1.6m



HAOYUN-22

Telescopic Gate

Gate row height 1.6m

NO.	1	2	3	4	5	6	7	8
Name	Bottom beam	Top beam	Main gate pillar	Auxiliary gate frame	Auxiliary gate pillar	Vertical bar	Gate row plate	Gantry
Material	6005-T5	6005-T5	6063-T5	6063-T5	6063-T5	6063-T5	6063-T5	6063-T5
Size(mm)	140*83*4.0	140*83*4.0	100*100*3.0	76*25*1.5	76*76*1.5	47*37*1.3	1.5mm AL plate carving	127*83*2.5
Surface Treatment	Fluorocarbon powder coating							

NO.	1	2	3	4	5	6	7
Name	Gate pillar	Top/Bottom beam	Gate vertical frame	Vertical bar	Gate row plate	Auxiliary Gate Pillar	Drive system
Material	6005-T6	6063-T5	6063-T5	6063-T5	6063-T5	6063-T6	24V Brushless motor, Can be connected to Face recognition access control system
Size(mm)	100*150*3.0	95*63*2.0	140*89*2.0	47*37*1.3	1.5 Al plate	110*110*1.5	
Surface Treatment	Fluorocarbon powder coating						

CMXM-12

Side Gate

Gate row height 1.6m



HAOYUN-17

Telescopic Gate

Gate row height 1.6m

NO.	1	2	3	4	5	6	7
Name	Bottom beam	Top beam	Main gate pillar	Auxiliary gate frame	Auxiliary gate pillar	Vertical bar	Gantry
Material	6005-T5	6005-T5	6063-T5	6063-T5	6063-T5	6063-T5	6063-T5
Size(mm)	140*83*4.0	140*83*4.0	100*100*3.0	76*25*1.5	76*76*1.5	47*37*1.3 57*47*1.3	127*83*2.5
Surface Treatment	Fluorocarbon powder coating						

NO.	1	2	3	4	5	6
Name	Gate pillar	Top/Bottom beam	Gate vertical frame	Vertical bar	Auxiliary Gate Pillar	Drive system
Material	6005-T6	6063-T5	6063-T5	6063-T5	6063-T6	24V Brushless motor, Can be connected to Face recognition access control system
Size(mm)	100*150*3.0	95*63*2.0	140*89*2.0	47*37*1.3 57*47*1.3	110*110*1.5	
Surface Treatment	Fluorocarbon powder coating					

CMXM-13

Side Gate

Gate row height 1.6m



HAOYUN-15

Telescopic Gate

Gate row height 1.6m

NO.	1	2	3	4	5	6	7
Name	Bottom beam	Top beam	Main gate pillar	Auxiliary gate frame	Auxiliary gate pillar	Gate row plate	Gantry
Material	6005-T5	6005-T5	6063-T5	6063-T5	6063-T5	6063-T5	6063-T5
Size(mm)	140*83*4.0	140*83*4.0	100*100*3.0	76*25*1.5	76*76*1.5	3.0mm thick aluminum plate carving	127*83*2.5
Surface Treatment	Fluorocarbon powder coating						

NO.	1	2	3	4	5	6
Name	Gate pillar	Top/Bottom beam	Gate vertical frame	Gate plate	Auxiliary Gate Pillar	Drive system
Material	6005-T6	6063-T5	6063-T5	6063-T5	6063-T6	24V Brushless motor , Can be connected to Face recognition access control system
Size(mm)	100*150*3.0	95*63*2.0	140*89*2.0	3.0 Al plate carving	110*110 *1.5	
Surface Treatment	Fluorocarbon powder coating					

CMXM-09

Side Gate

Gate row height 1.6m



HAOYUN-01

Telescopic Gate

Gate row height 1.6m

NO.	1	2	3	4	5	6	7	8	9
Name	Bottom beam	Top beam	Main gate pillar	Auxiliary gate frame	Auxiliary gate pillar	Gate row bar	Gate vertical bar	Decoration part	Gantry
Material	6005-T5	6005-T5	6063-T5	6063-T5	6063-T5	6063-T5	6063-T5	6063-T5	6063-T5
Size(mm)	140*83*4.0	140*83*4.0	100*100*3.0	76*25*1.5	76*76*1.5	47*37*1.3	47*37*1.3	Al casting	127*83*2.5
Surface Treatment	Fluorocarbon powder coating								



HAOYUN-04

Telescopic Gate

Gate row height 1.6m

NO.	1	2	3	4	5	6	7	8
Name	Bottom beam	Top beam	Main gate pillar	Auxiliary gate frame	Auxiliary gate pillar	Gate vertical bar	Gate plate	Gantry
Material	6005-T5	6005-T5	6063-T5	6063-T5	6063-T5	6063-T5	6063-T5	6063-T5
Size(mm)	140*83*4.0	140*83*4.0	100*100*3.0	76*25*1.5	76*76*1.5	47*37*1.3	1.5mm thick aluminum plate carving	127*83*2.5
Surface Treatment	Fluorocarbon powder coating							

CMXM-31

Side Gate

Gate row height 1.6m

NO.	1	2	3	4	5	6	7
Name	Gate pillar	Top/Bottom beam	Gate vertical frame	Vertical bar	Gate plate	Auxiliary Gate Pillar	Drive system
Material	6005-T6	6063-T5	6063-T5	6063-T5	6063-T5	6063-T6	24V Brushless motor , Can be connected to Face recognition access control system
Size(mm)	100*150*3.0	95*63*2.0	140*89*2.0	47*37*1.3	1.5 Al plate	110*110 *1.5	
Surface Treatment	Fluorocarbon powder coating						

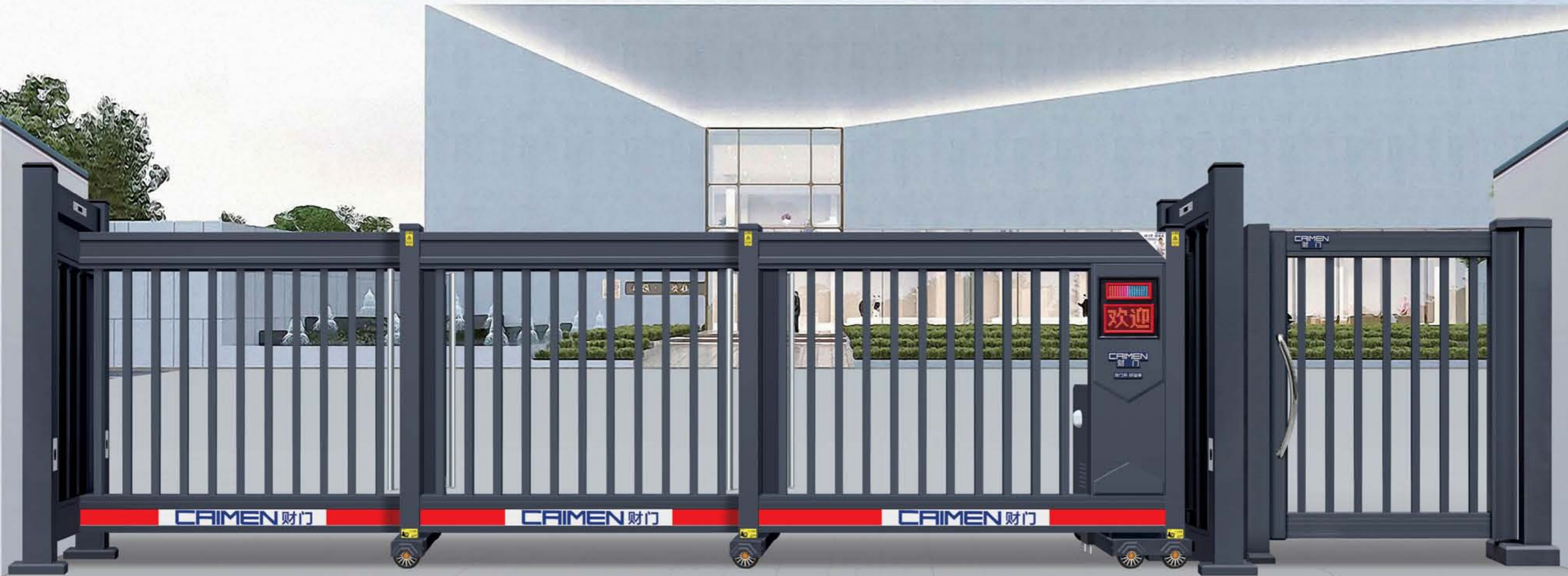

HAOYUN-06

Telescopic Gate

Gate row height 1.6m

NO.	1	2	3	4	5	6	7
Name	Bottom beam	Top beam	Main gate pillar	Auxiliary gate frame	Auxiliary gate pillar	Gate vertical bar	Gantry
Material	6005-T5	6005-T5	6063-T5	6063-T5	6063-T5	6063-T5	6063-T5
Size(mm)	140*83*4.0	140*83*4.0	100*100*3.0	76*25*1.5	76*76*1.5	47*37*1.3	127*83*2.5
Surface Treatment	Fluorocarbon powder coating						

NO.	1	2	3	4	5	6
Name	Gate pillar	Top/Bottom beam	Gate vertical frame	Vertical bar	Auxiliary Gate Pillar	Drive system
Material	6005-T6	6063-T5	6063-T5	6063-T5	6063-T6	24V Brushless motor, Can be connected to Face recognition access control system
Size(mm)	100*150*3.0	95*63*2.0	140*89*2.0	47*37*1.3	110*110*1.5	
Surface Treatment	Fluorocarbon powder coating					

CMXM-05

Side Gate

Gate row height 1.6m



HAOYUN-06B

Telescopic Gate

Gate row height 1.6m

NO.	1	2	3	4	5	6	7
Name	Bottom beam	Top beam	Gate main frame	Auxiliary gate frame	Gate pillar	Vertical bar	Gantry
Material	6005-T5	6005-T5	6063-T5	6063-T5	6063-T5	Stainless steel	6063-T5
Size(mm)	140*83*4.0	140*83*4.0	100*100*3.0	76*25*1.5	76*76*1.5	47*37*1.3	127*83*2.5
Surface Treatment	Fluorocarbon powder coating						

NO.	1	2	3	4	5	6	7
Name	Gate pillar	Top/Bottom beam	Gate vertical frame	Vertical bar	Vertical bar insert	Auxiliary Gate Pillar	Drive system
Material	6005-T6	6063-T5	6063-T5	6063-T5	6063-T6	6063-T6	24V Brushless motor , Can be connected to Face recognition access control system
Size(mm)	100*150*3.0	95*63*2.0	140*89*2.0	47*37*1.3	1.5	110*110 *1.5	
Surface Treatment	Fluorocarbon powder coating						

CMXM-05B

Side Gate

Gate row height 1.6m



HAOYUN-05A

Telescopic Gate

Gate row height 1.6m

NO.	1	2	3	4	5	6	7
Name	Bottom beam	Top beam	Gate main frame	Auxiliary gate frame	Gate pillar	Vertical bar	Gantry
Material	6005-T5	6005-T5	6063-T5	6063-T5	6063-T5	Stainless steel	6063-T5
Size(mm)	140*83*4.0	140*83*4.0	100*100*3.0	76*25*1.5	76*76*1.5	128*22*1.2	127*83*2.5
Surface Treatment	Fluorocarbon powder coating						

NO.	1	2	3	4	5	6
Name	Gate pillar	Top/Bottom beam	Gate vertical frame	Vertical bar	Auxiliary gate frame	Drive system
Material	6005-T6	6063-T5	6063-T5	6063-T5	6063-T6	24V Brushless motor , Can be connected to Face recognition access control system
Size(mm)	100*150*3.0	95*63*2.0	140*89*2.0	128*22*1.2	110*110 *1.5	
Surface Treatment	Fluorocarbon powder coating					

CMXM-22

Side Gate

Gate row height 1.6m



HAOYUN-08
Telescopic Gate

Gate row height 1.6m

NO.	1	2	3	4	5	6	7
Name	Bottom beam	Top beam	Main gate pillar	Auxiliary gate frame	Auxiliary gate pillar	Gate plate	Gantry
Material	6005-T5	6005-T5	6063-T5	6063-T5	6063-T5	6063-T5	6063-T5
Size(mm)	140*83*4.0	140*83*4.0	100*100*3.0	76*25*1.5	76*76*1.5	3.0mm thick aluminum plate carving	127*83*2.5
Surface Treatment	Fluorocarbon powder coating						

CMXM-32
Side Gate

Gate row height 1.6m



HAOYUN-09

Telescopic Gate

Gate row height 1.6m

NO.	1	2	3	4	5	6	7
Name	Bottom beam	Top beam	Main gate pillar	Auxiliary gate frame	Auxiliary gate pillar	Gate row louvers	Gantry
Material	6005-T5	6005-T5	6063-T5	6063-T5	6063-T5	6063-T5	6063-T5
Size(mm)	140*83*4.0	140*83*4.0	100*100*3.0	76*25*1.5	76*76*1.5	60*22*1.2	127*83*2.5
Surface Treatment	Fluorocarbon powder coating						

NO.	1	2	3	4	5	6
Name	Gate pillar	Top/Bottom beam	Gate vertical frame	Gate louver material	Auxiliary Gate Pillar	Drive system
Material	6005-T6	6063-T5	6063-T5	6063-T5	6063-T6	24V Brushless motor , Can be connected to Face recognition access control system
Size(mm)	100*150*3.0	95*63*2.0	140*89*2.0	60*22*1.2	110*110 *1.5	
Surface Treatment	Fluorocarbon powder coating					

CMXM-07

Side Gate

Gate row height 1.6m

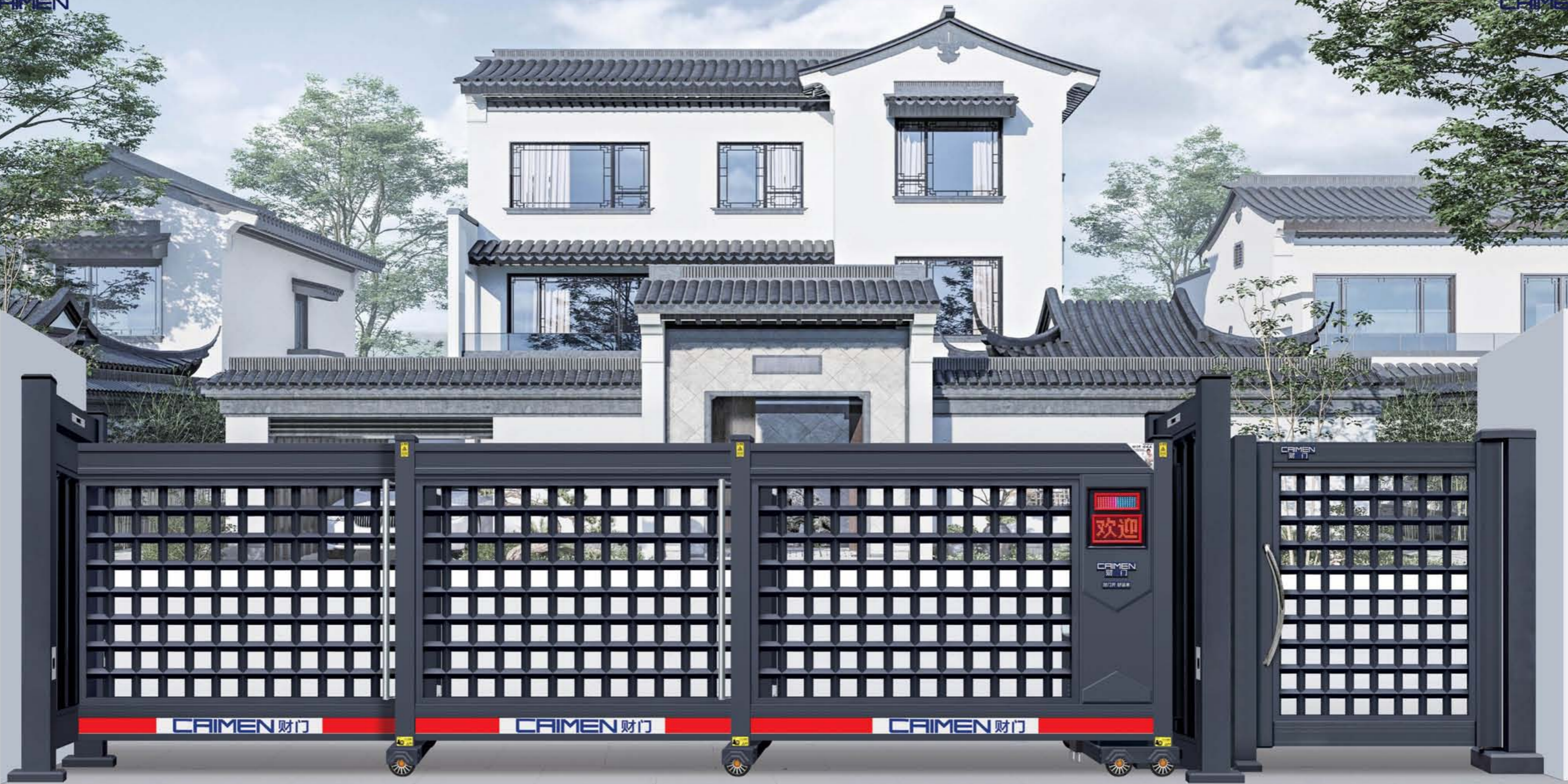

HAOYUN-37

Telescopic Gate

Gate row height 1.6m

NO.	1	2	3	4	5	6	7	8
Name	Bottom beam	Top beam	Main gate pillar	Auxiliary gate frame	Auxiliary gate pillar	Vertical bar	Gate row plate	Gantry
Material	6005-T5	6005-T5	6063-T5	6063-T5	6063-T5	Stainless steel	6063-T5	6063-T5
Size(mm)	140*83*4.0	140*83*4.0	100*100*3.0	76*25*1.5	76*76*1.5	30*30*0.8 40*40*0.8	1.5mm thick aluminum plate carving	127*83*2.5
Surface Treatment	Fluorocarbon powder coating							

NO.	1	2	3	4	5	6
Name	Gate pillar	Top/Bottom beam	Gate vertical frame	Vertical bar	Auxiliary gate pillar	Drive system
Material	6005-T6	6005-T5	6063-T5	Stainless steel	6063-T6	24V Brushless motor , Can be connected to Face recognition access control system
Size(mm)	100*150*3.0	95*63*2.0	140*89*2.0	30*30*0.8 40*40*0.8	110*110*1.5	
Surface Treatment	Fluorocarbon powder coating					

CMXM-37

Side Gate

Gate row height 1.6m

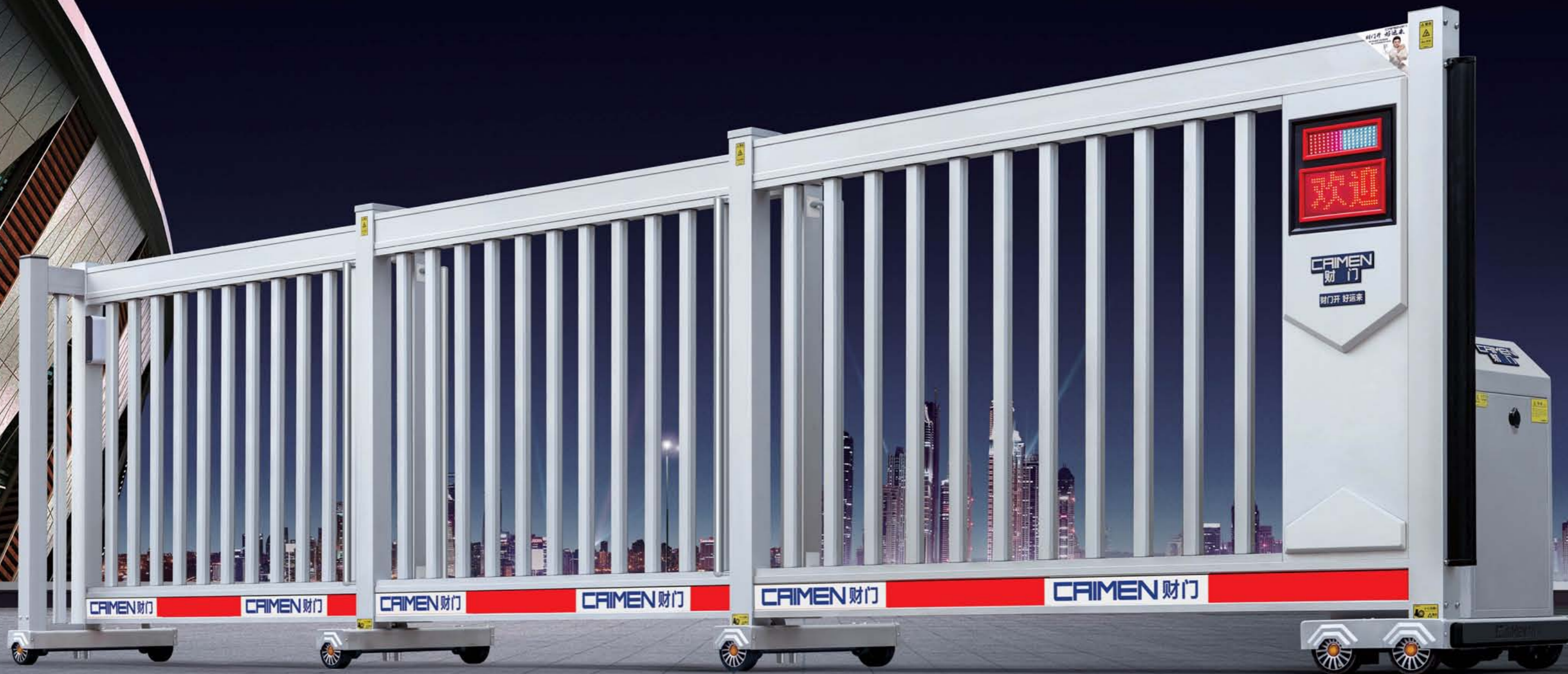

HAOYUN-06C Silver

Telescopic Gate

Gate row height 1.6m

NO.	1	2	3	4	5	6	7
Name	Bottom beam	Top beam	Main gate pillar	Auxiliary gate frame	Auxiliary gate pillar	Gate vertical bar	Gantry
Material	6005-T5	6005-T5	6063-T5	6063-T5	6063-T5	6063-T5	6063-T5
Size(mm)	122*66*3.0	122*66*3.0	80*90*3.0	60*25*1.0	60*60*1.0	47*37*0.9	127*83*2.5
Surface Treatment	Fluorocarbon powder coating						



HAOYUN-06C Dark gray

Telescopic Gate

Gate row height 1.6m

NO.	1	2	3	4	5	6	7
Name	Bottom beam	Top beam	Main gate pillar	Auxiliary gate frame	Auxiliary gate pillar	Gate vertical bar	Gantry
Material	6005-T5	6005-T5	6063-T5	6063-T5	6063-T5	6063-T5	6063-T5
Size(mm)	122*66*3.0	122*66*3.0	80*90*3.0	60*25*1.0	60*60*1.0	47*37*0.9	127*83*2.5
Surface Treatment	Fluorocarbon powder coating						



HONGYUN-01 Dark gray
Silver

Retractable Gates

Gate row height 1.6m

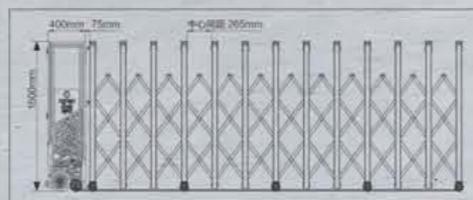



CMXM-05

Side Gate

Gate row height 1.6m

NO.	1	2	3	4	5	6
Name	Gate pillar	Top/Bottom beam	Gate vertical frame	Vertical bar	Auxiliary gate pillar	Drive system
Material	6005-T6	6005-T5	6063-T5	6063-T5	6063-T6	24V Brushless motor , Can be connected to Face recognition access control system
Size(mm)	100*150*3.0	95*63*2.0	140*89*2.0	47*37*1.3	110*110*1.5	
Surface Treatment	Fluorocarbon powder coating					

HONGYUN-02 Dark gray

Retractable Gates

Gate row height 1.6m

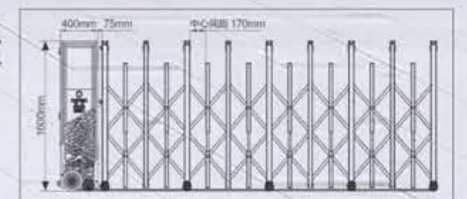



CMXM-05 Side Gate

Gate row height 1.6m

NO.	1	2	3	4	5	6
Name	Gate pillar	Top/Bottom beam	Gate vertical frame	Vertical bar	Auxiliary gate pillar	Drive system
Material	6005-T6	6005-T5	6063-T5	6063-T5	6063-T6	24V Brushless motor Can be connected to Face recognition access control system
Size(mm)	100*150*3.0	95*63*2.0	140*89*2.0	47*37*1.3	110*110*1.5	
Surface Treatment	Fluorocarbon powder coating					

HONGYUN-02 Silver Retractable Gates

Gate row height 1.6m

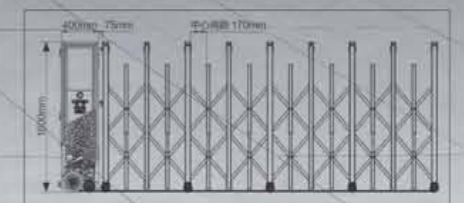



HONGYUN-03 Dark gray
Silver

Retractable Gates

Gate row height 1.6m

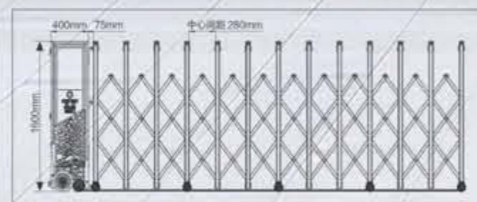

NO.	1	2	3	4	5	6
Name	Gate pillar	Top/Bottom beam	Gate vertical frame	Vertical bar	Auxiliary gate pillar	Drive system
Material	6005-T6	6005-T5	6063-T5	6063-T5	6063-T6	24V Brushless motor Can be connected to Face recognition access control system
Size(mm)	100*150*3.0	95*63*2.0	140*89*2.0	47*37*1.3	110*110*1.5	
Surface Treatment	Fluorocarbon powder coating					

CMXM-05

Side Gate

Gate row height 1.6m

Side Gate Schematic Diagram

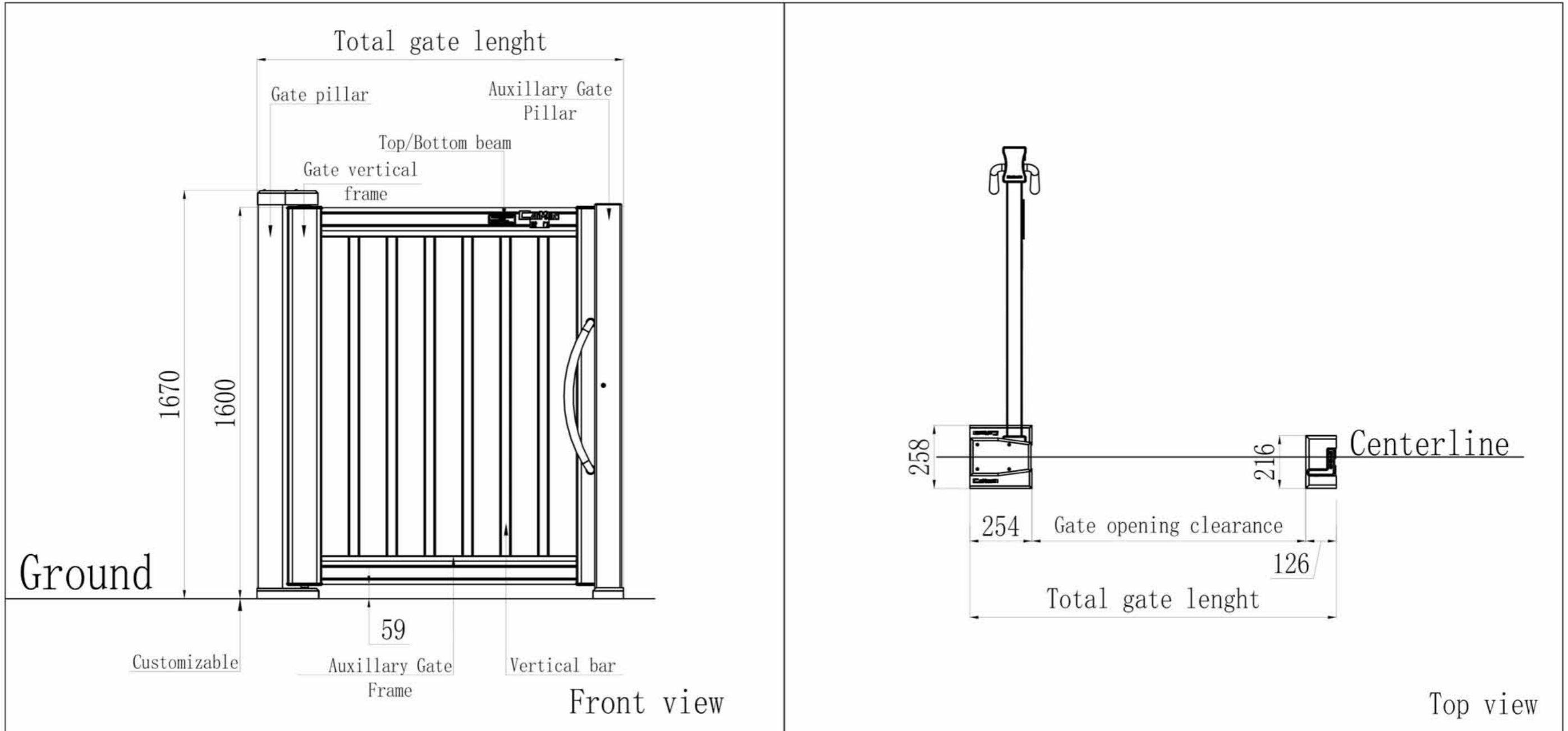

Name	Gate pillar	Gate vertical frame	Top/Bottom beam	Vertical bar	Auxillary Gate Frame	Auxillary Gate Pillar
Material	6063-T6	6063-T6	6063-T6	6063-T6	6063-T6	6063-T6
Size mm	150*100* Thickness 3.0	140*89* Thickness 2.0	95*63* Thickness2.0	47*37* Thickness1.3	60*25* Thickness1.3	110*110 Thickness1.5



TYPK-2408

Swing Gate

Private customization

NO.	1	2	3
Name	Gate main frame	Gate row plate	stand column
Material	6005-T6	6063-T5	6063-T5
Size(mm)	60*60*1.5	3.0	100*100*3.0
Surface Treatment	Fluorocarbon powder coating		



CMXM-1802

Swing Gate | Gate row height 1.6m



CMXM-1801

Swing Gate | Gate row height 1.6m



CMXM-05

Swing Gate | Gate row height 1.6m



CMXM-2305

Swing Gate | Gate row height 1.6m

No.	1	2	3	4	5	6	7
Name	Main column	Auxiliary column	Left and right material	Top and bottom material	crosswise	Shaft stock	Drive system
Material	6005-T6	6005-T5	6063-T5	6063-T5	6063-T5	6063-T5	24V Brushless motor Can be connected to face recognition access control system
Size(mm)	127*83*2.5	110*110*1.5	70*60*1.5	72*51*1.5	45*25*0.8	47*27*0.8	
Surface treatment	Fluorocarbon powder coating						



WL-202
Fence

NO.	1	2	3
Name	Crossbar	Vertical bar	Decoration part
Material	6005-T6	6063-T5	6063-T5
Size(mm)	60*35*1.5	75*25*1.5	Al die casting
Surface Treatment	Fluorocarbon powder coating		



WL-208
Fence

NO.	1	2
Name	Crossbar	Vertical bar
Material	6005-T6	6063-T5
Size(mm)	60*35*1.5	50*40*1.3
Surface Treatment	Fluorocarbon powder coating	



WL-206
Fence

NO.	1	2
Name	Crossbar	Vertical bar
Material	6005-T6	6063-T5
Size(mm)	80*40*1.5	75*25*1.5
Surface Treatment	Fluorocarbon powder coating	



WL-209
Fence

NO.	1	2	3
Name	Crossbar	Vertical bar	Decoration part
Material	6005-T6	6063-T5	6063-T5
Size(mm)	80*40*1.5	30*30*1.5	Al die casting
Surface Treatment	Fluorocarbon powder coating		